

Thank you for choosing Amerlife to be a part of your life. We value your business, and constantly strive to provide you only top-quality products and services. Contact us if we can be of further assistance, we'd love to hear your advice.

Our E-mail address: support@wepatio.com



Warm Tips:

- 1.If you need any help or received damaged or missing parts, please feel free to contact Amerlife customer support email: support@wepatio.com
- 2.Please check the pack content before attempting to construct the greenhouse.
- 3.Read the manual carefully and familiarise yourself with the procedure before assembling it.
- 4.Please do not locate the product in the area exposed to excessive winds.
- 5.It is recommended that the greenhouse to be assembled by at least two people.

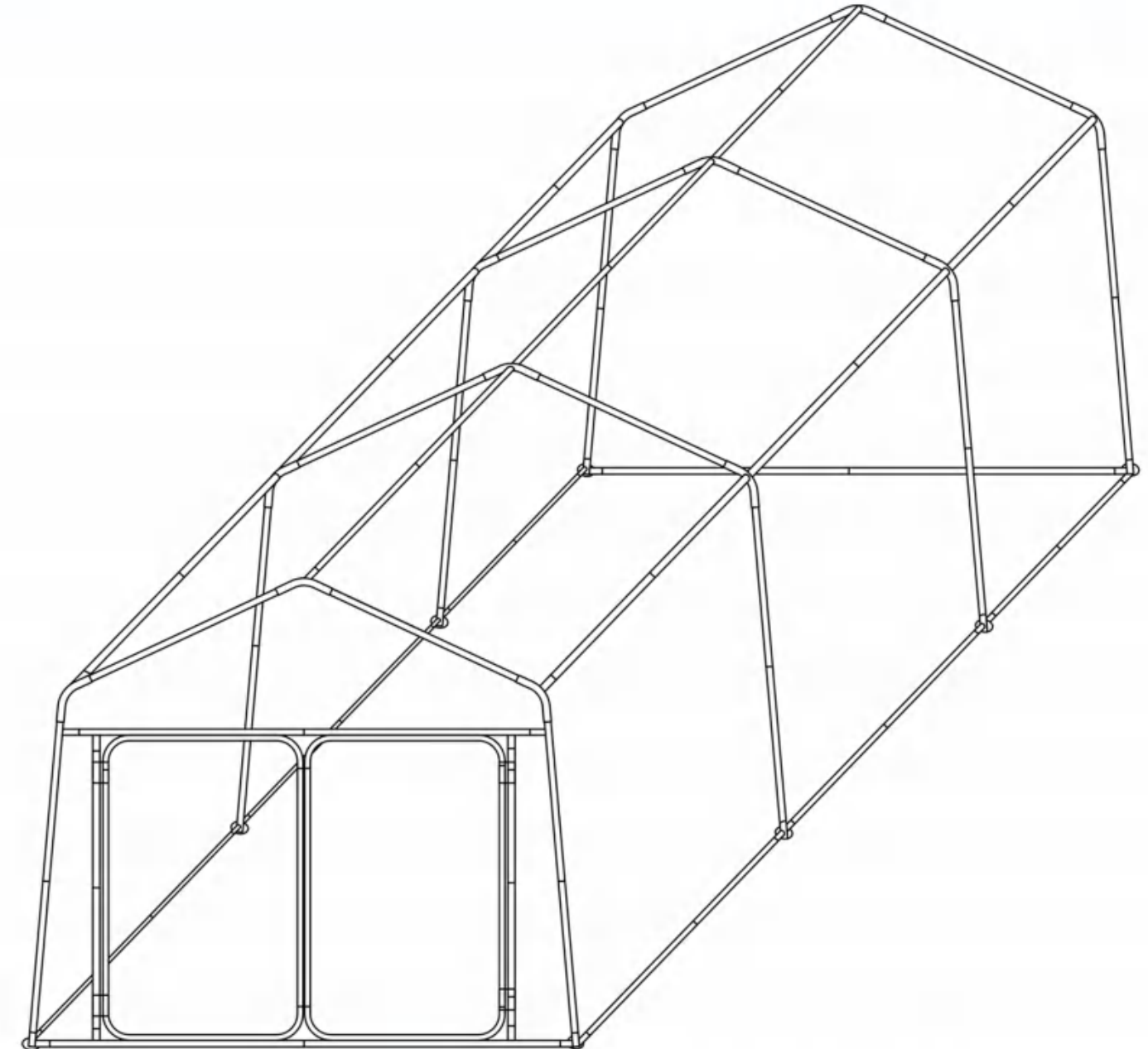

SKU: 1007030114E

Email: support@wepatio.com

Phone: 901-347-2181

Revision date: **24.1.15**

WARNING

Manufacturer and seller expressly disclaim any and all liability for personal injury, property damage, or loss, whether direct, indirect, or incidental, resulting from the incorrect attachment, improper use, inadequate maintenance, or neglect of this product.

Accessories List

1 1012mm	1A 1012mm	1B 1012mm	2 1460mm	2A 1460mm	3 1150mm	4 1468mm	5 1468mm	6 935mm	7 1306mm
2PCS	6PCS	8PCS	9PCS	9PCS	8PCS	7PCS	7PCS	4PCS	1PCS
8 1306mm	9 934mm	10 934mm	11 1558mm	12 1558mm	13 1468mm	14 1468mm	15		
1PCS	2PCS	2PCS	2PCS	2PCS	1PCS	1PCS	16PCS		
A	A1	B	C 114°	D 142°	E 114°	F 142°	G	G1	
2PCS	2PCS	4PCS	4PCS	2PCS	4PCS	2PCS	2PCS	2PCS	
H M6*35	I M6*40	J M6	K M6	L M6	N	M ∅25	P 布套	Q 门套	S
20PCS	4PCS	24PCS	1PCS	1PCS	2PCS	6PCS	1PCS	2PCS	1PCS

STEP6

To make the greenhouse more sturdy, after assemble the cover install the pressed film clips according to the marked points in the picture.

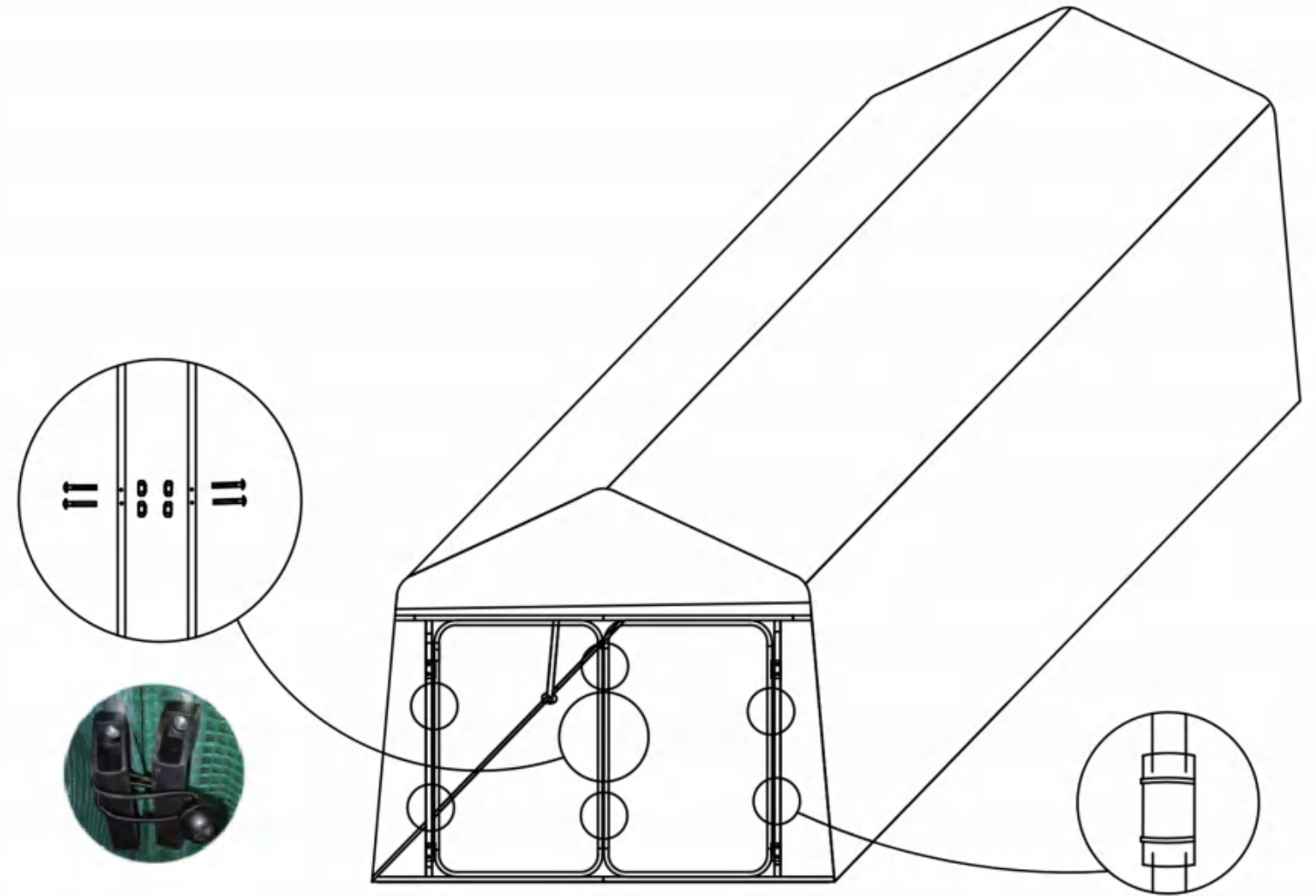

How to make the whole greenhouse more solid in strong wind or snow?

1. Make all the screws in perfectly fixed status
2. Use the buckle and ground pegs included
3. Dig a trench at the bottom of the frame, and bury the bottom steel pipe and cover with soil (this way is very efficient)
4. Let the whole greenhouse against the wall
5. Keep the door closed when not using

HARDWARE

part List	Qty
Q	2
N	2
M	6
S	1
I	4
J	4

STEP5

You may need the help of a ladder when installing the cover

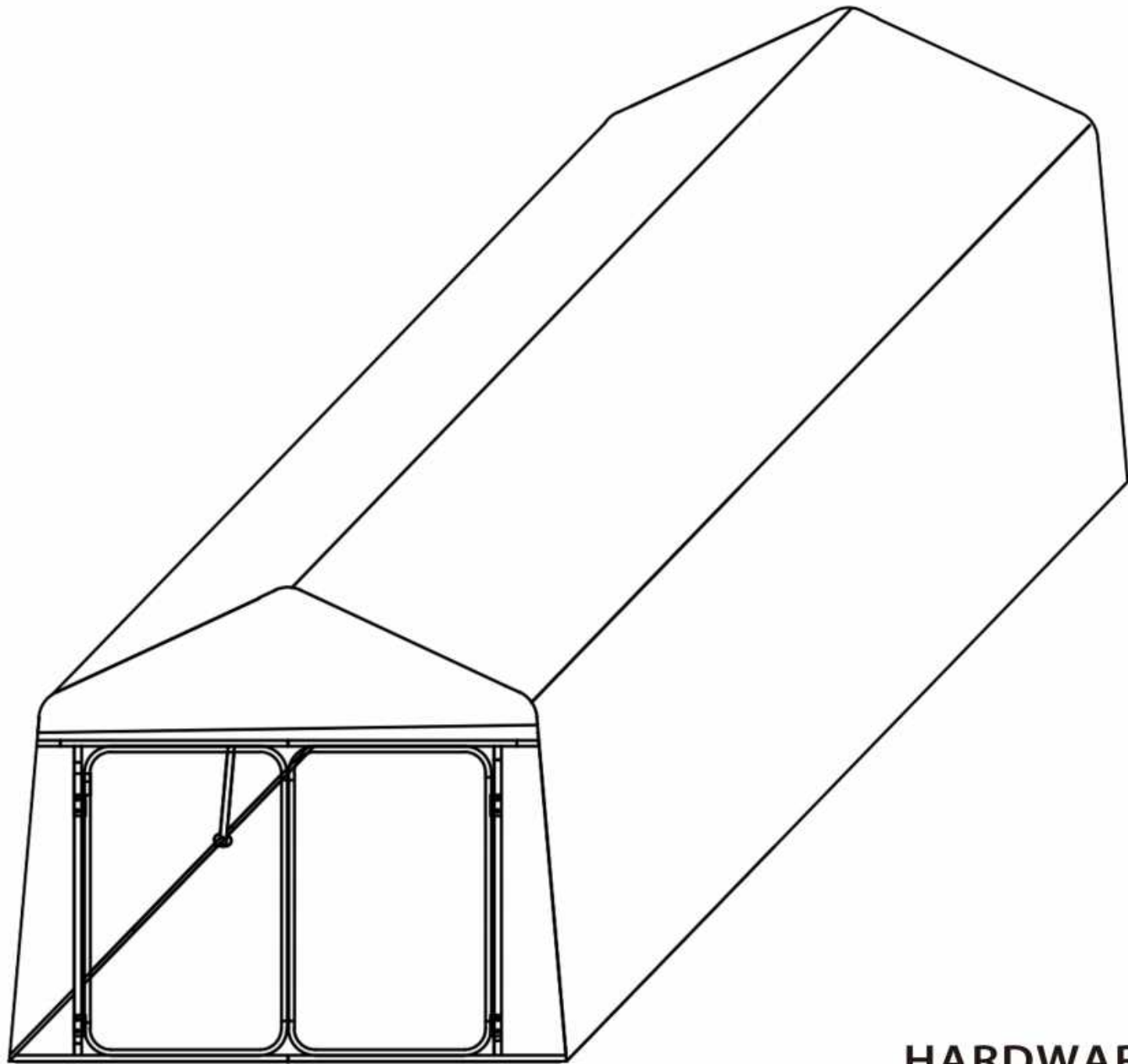





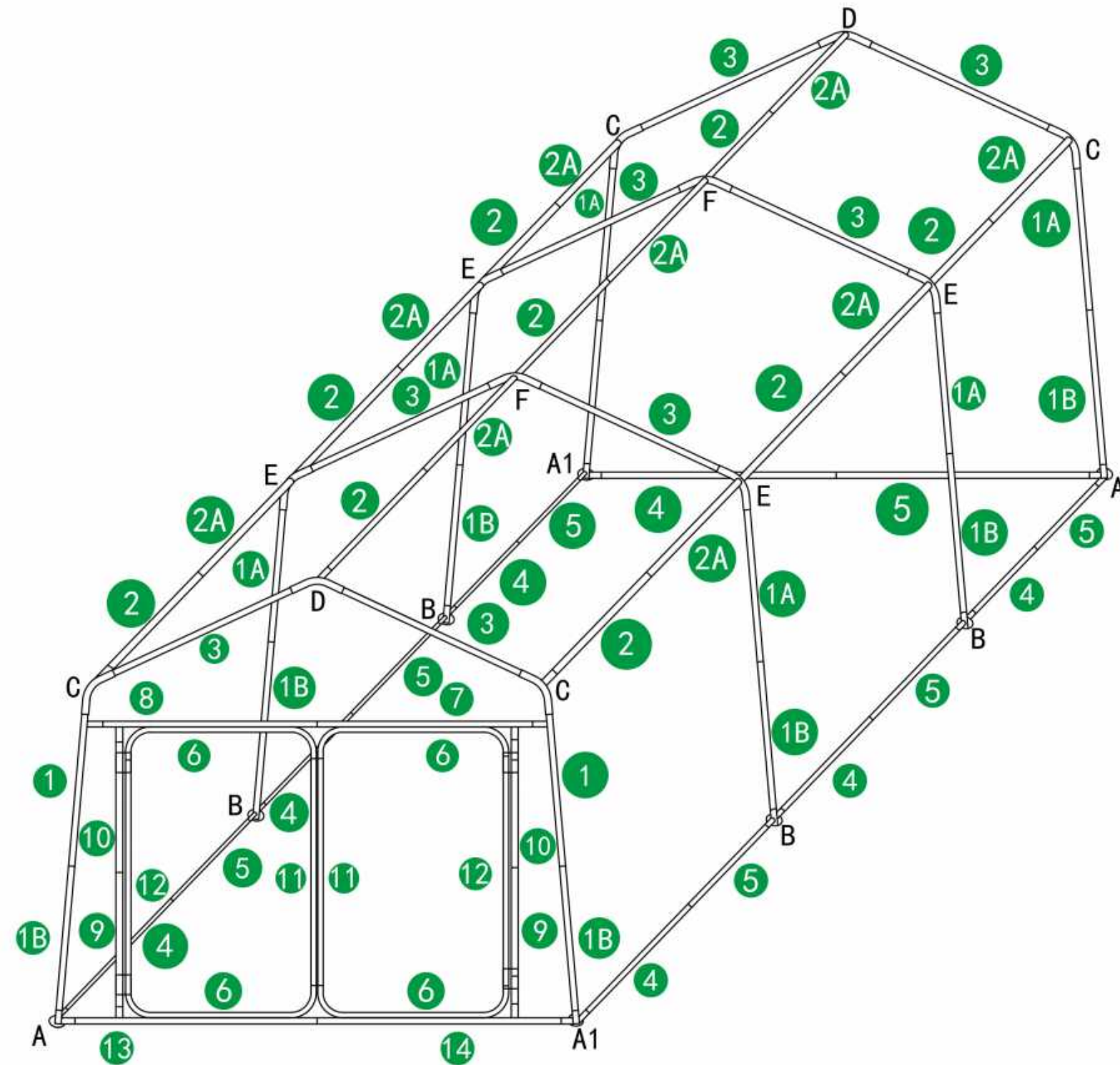

HARDWARE

Part List	Picture	Qty
P		1



HARDWARE

Part List	Picture	Qty	Part List	Picture	Qty
D		2	2		9
E		4	2A		9
F		2	3		8
			C		4

STEP 1

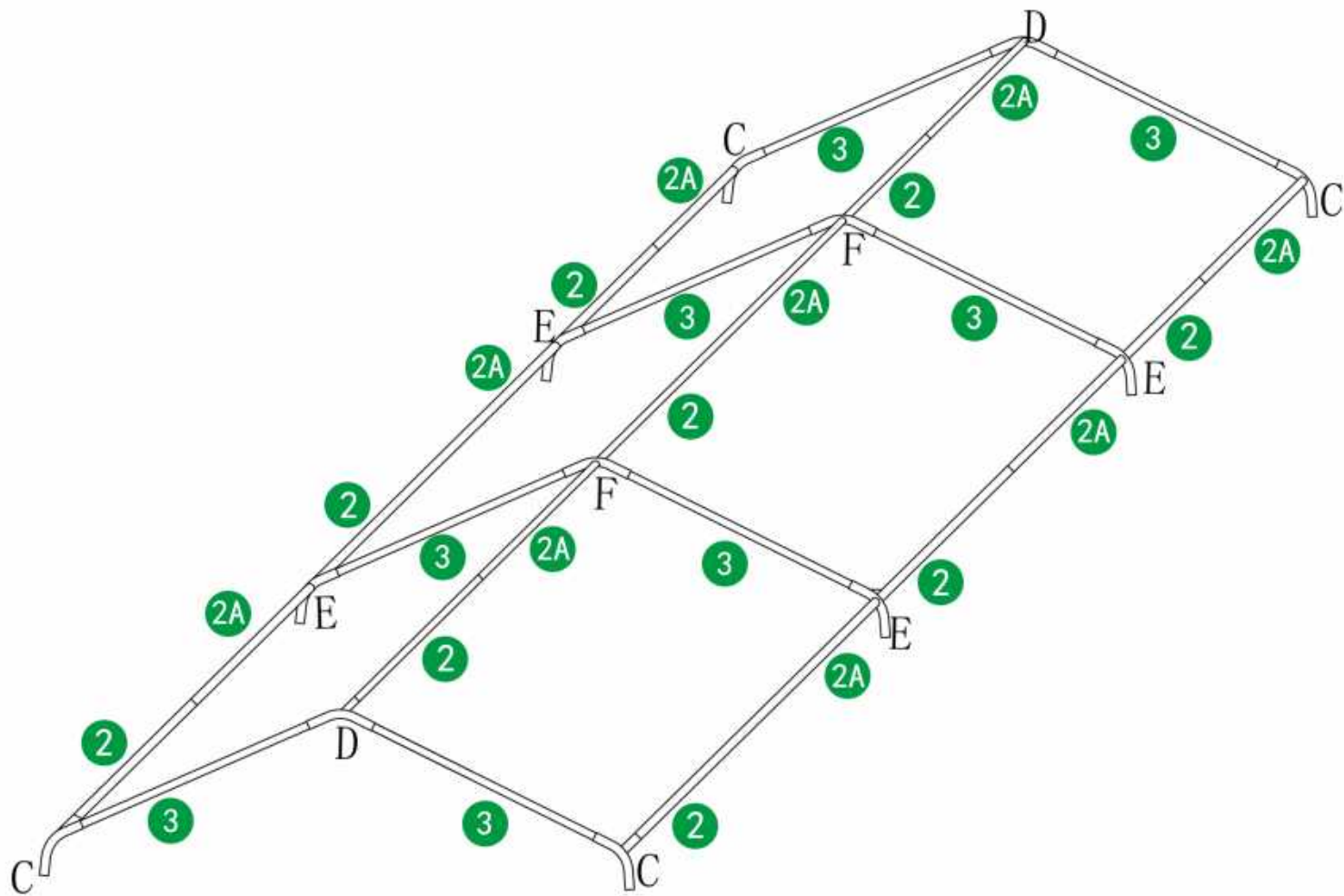



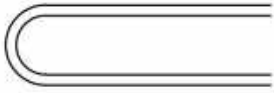

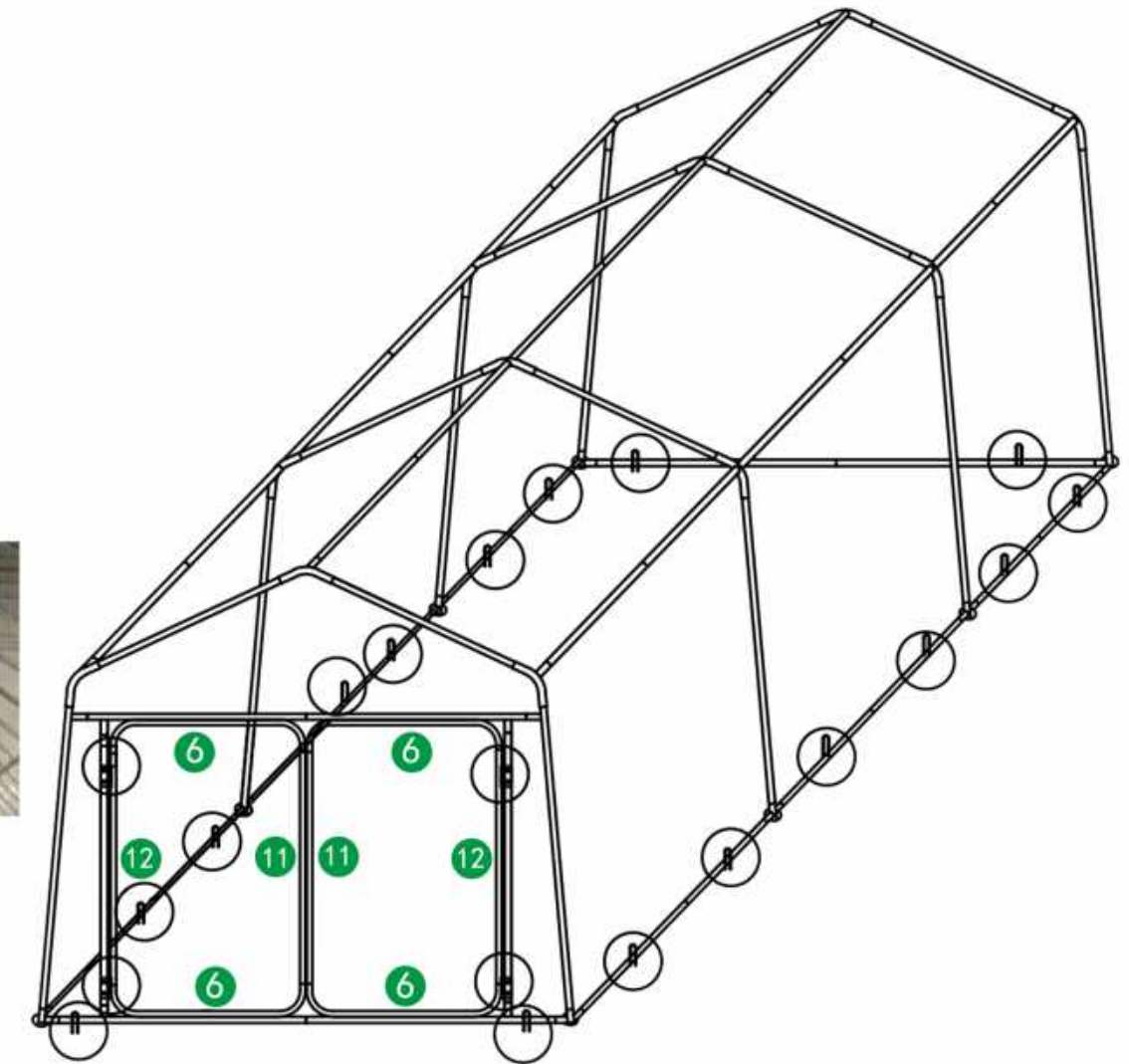

HARDWARE

Part List	Picture	Qty
15		16

STEP 4 -3

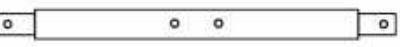

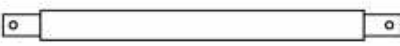
HARDWARE

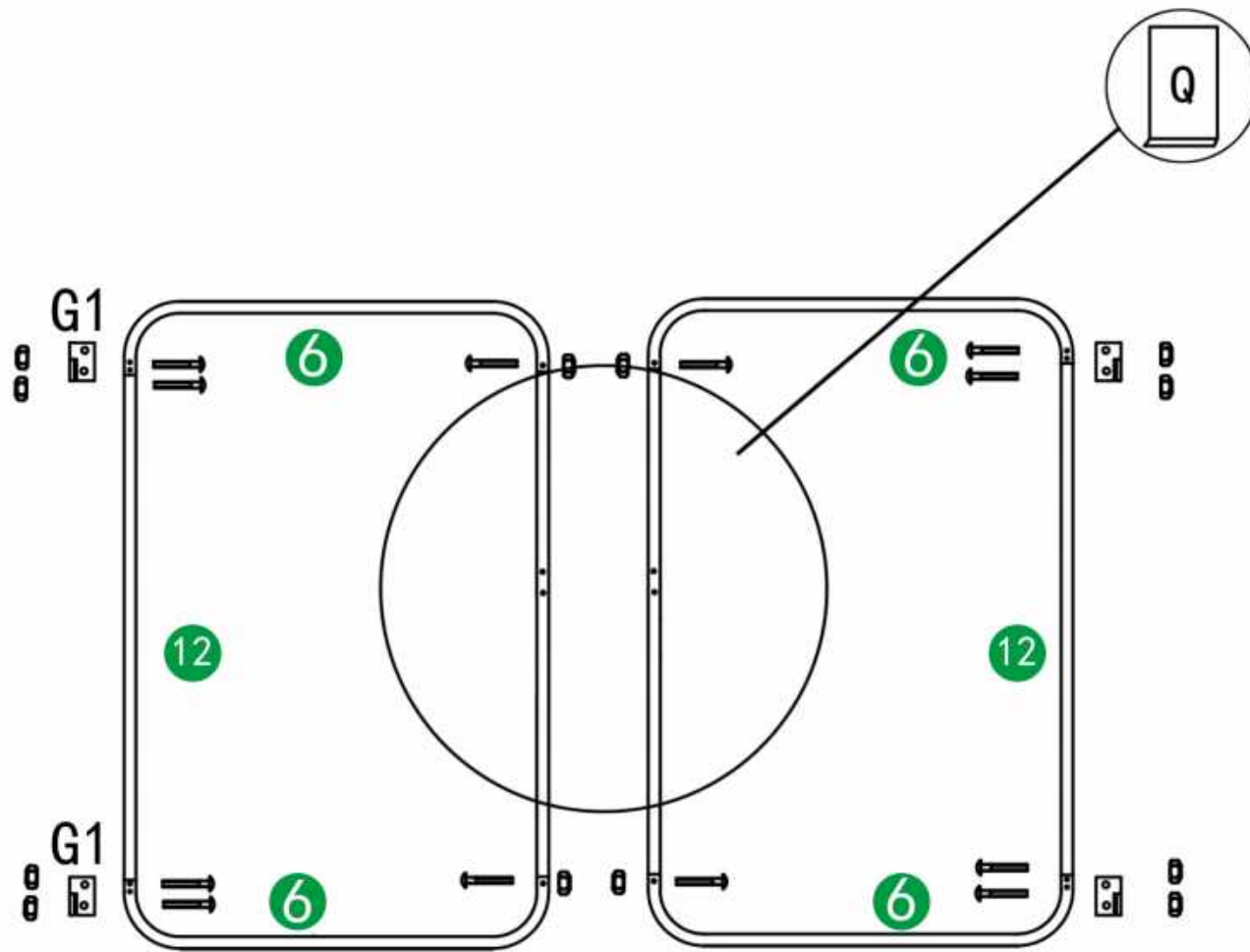

Part List	Picture	Qty	Part List	Picture	Qty
6		4	J		12
11		2	G		2
12		2	G1		2
H		12			



STEP 4-2

The door hinge should be installed on the outside of the door.

HARDWARE

Part List	Picture	Qty
1		2
1A		6
1B		8



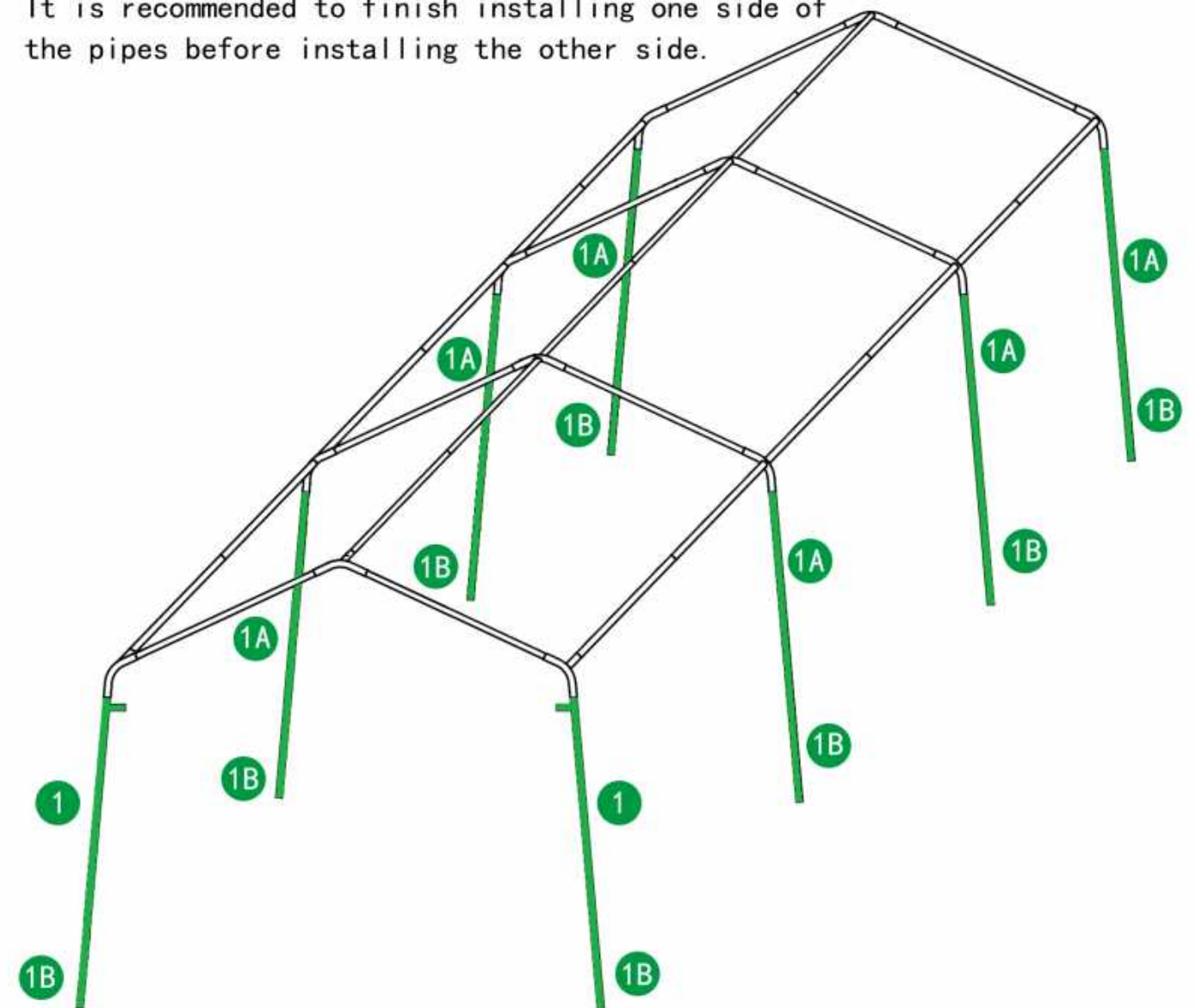

STEP 2

Install 1, 1A, then 1B.

It is recommended to finish installing one side of the pipes before installing the other side.

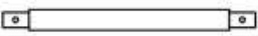

HARDWARE

Part List	Picture	Qty
4		7
5		7
A		2
A1		2
B		4

STEP 3





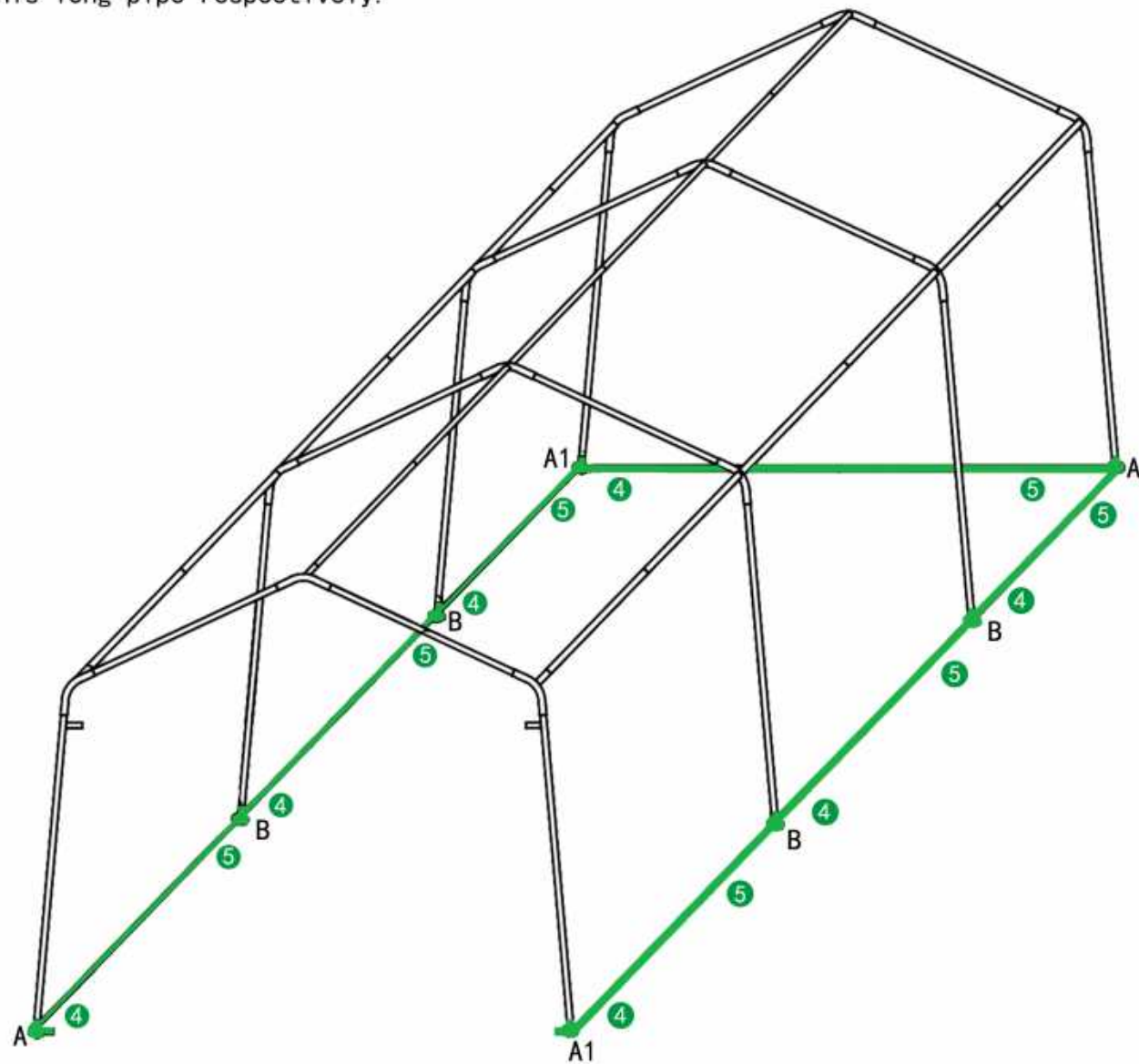

Install A, A1, B, then part 4 and 5.

It is recommended to connect part 4 and 5 first, and then connect the two ends of this long pipe respectively.

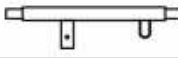
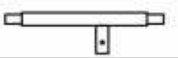
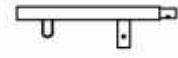
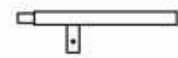

5

HARDWARE

Part List	Picture	Qty	Part List	Picture	Qty
7		1	13		1
8		1	14		1
9		2	G/G1		4
10		2	H		8
			J		8

STEP 4-1

4-1:

Attention:

the hinge with protruding part is facing inwards.

After installing pipe 9 and 10, connect pipe 7 and 8.

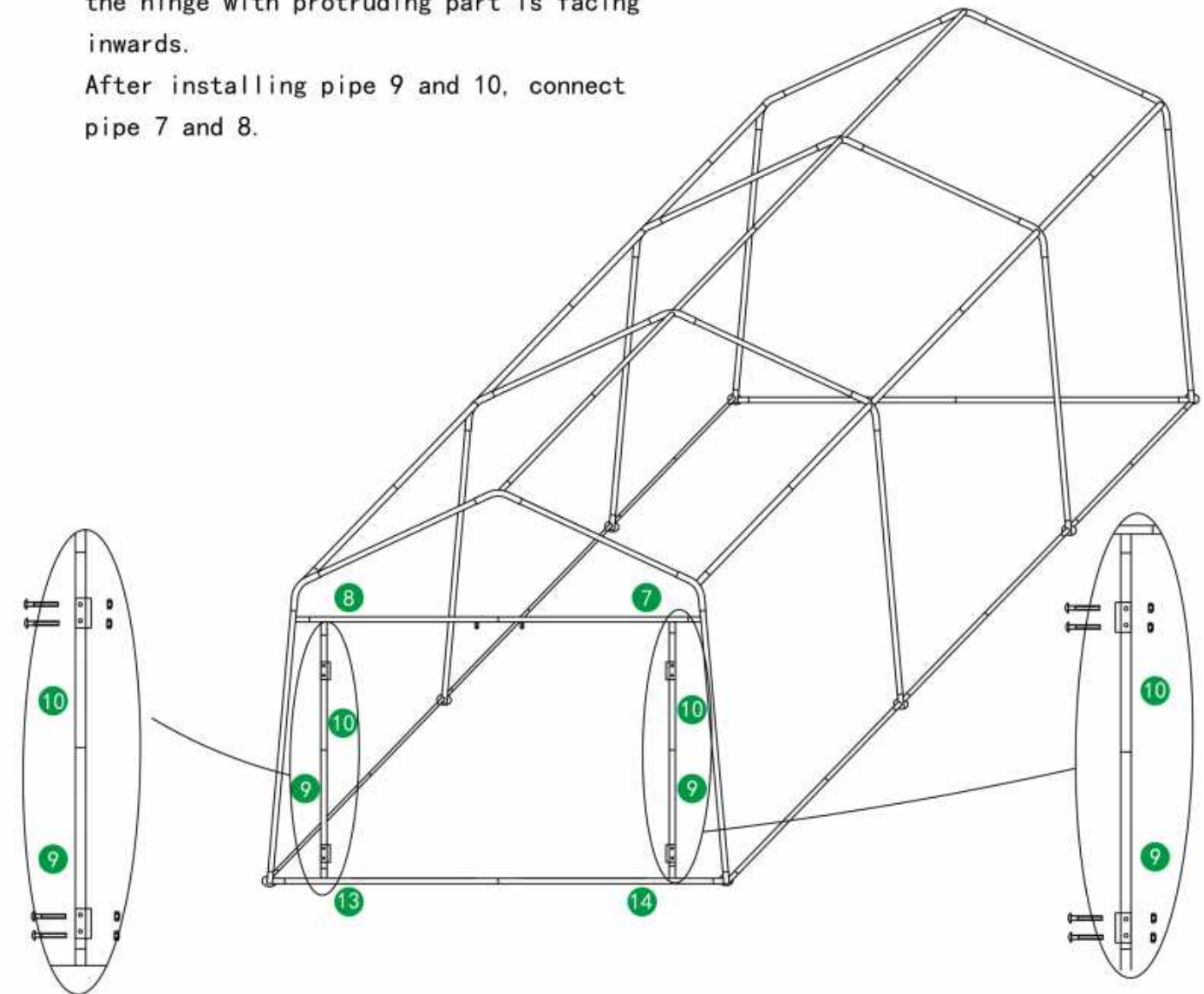

6