

CONTEMPORARY SOFA

Assembly Instruction

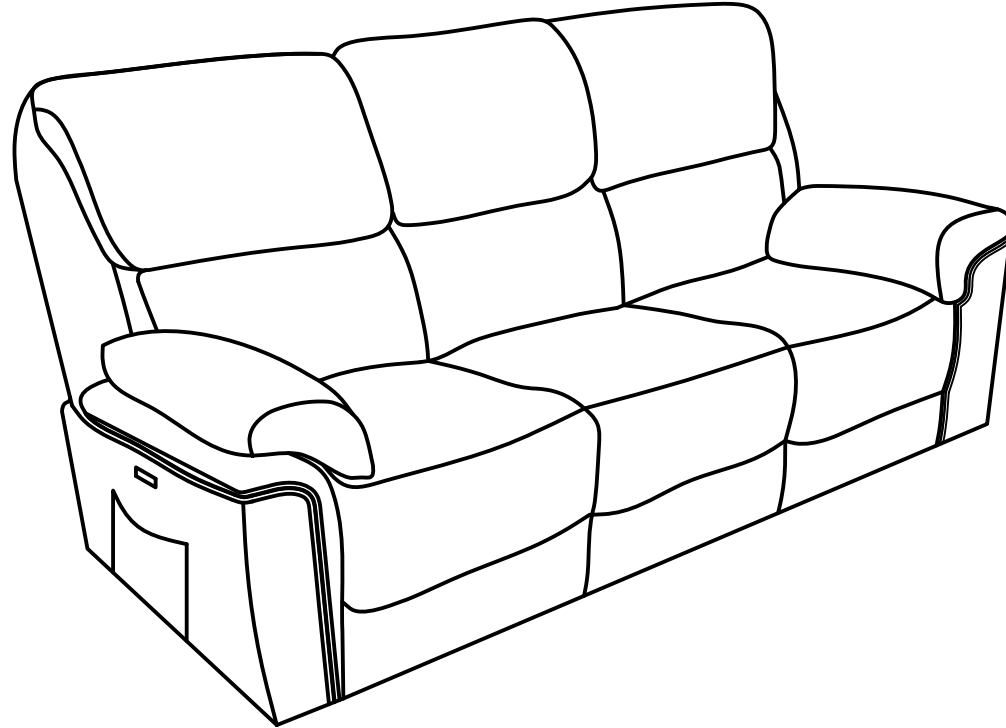

NOTE:

Delivered with TWO PACKAGES with TWO TRACKINGS.may NOT be delivered at the same time.

Any question please feel free to contact us:
support@merluxyhome.com TEL:901-347-2181
We will provide further assistance within 24 hours.

Dear Customers,

Thank you for purchasing our product.Please read this instruction manual carefully after receiving this product. It will help you assemble this product quickly,safely and correctly.You can keep this manual for future reference.



Safety and Care Advice

Important – Please read these instructions fully before starting assembly

Thanks for your purchase. Before assembling, please follow the instructions to check if all the spare parts and screws are intact.

- Considering the size and weight of the sofa, we recommend two adults to assemble the sofa, on a carpeted or padded area, in the room that it is intended for. Approximate assembly time: 30 minutes.
- Keep all components and packaging out of reach of children or animals to avoid the risk of choking or suffocation.
- Please do not throw away any of the packaging or the instruction until you have checked all the components and hardware and the furniture is fully assembled. Please ensure that the packaging is disposed in a safe and environmentally friendly way.
- Please do not take off the cover, and do not wash.

Your cushions come vacuum packed and sealed for shipping. To restore the cushion's original shape, follow the steps below.

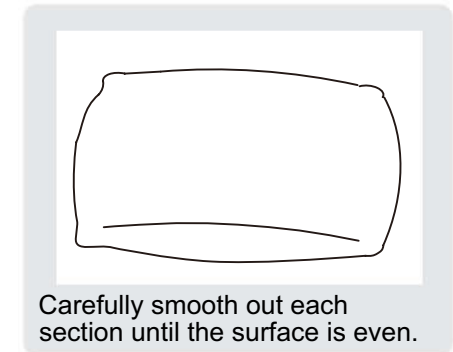
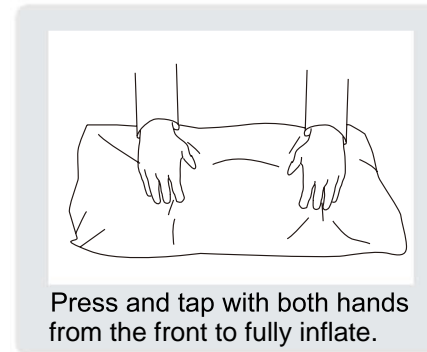
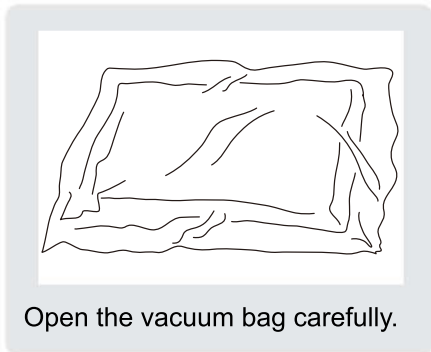





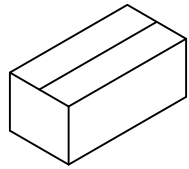

After packing up, place them somewhere dry and ventilated. After about 72-96 hours, it can be restored to the best-use condition.





BOX 1



SOFA PART

Ⓐ		Left And Middle Seat Base	X1	Ⓙ		Left Armrest Pat	X1
Ⓒ		Left Back Frame	X1	Ⓚ		Right Armrest Pat	X1
Ⓓ		Middle Back Frame	X1				
Ⓔ		Left Backrest Cover	X1				
Ⓕ		Middle Backrest Cover	X1				



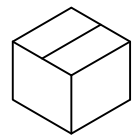

HARDWARE PART

a		Latch	X4
b		Allen key	X1
c		Screw	X8
d		Power	X1

BOX 2



SOFA PART

Ⓑ		Right Seat Base	X1
Ⓖ		Right Backrest Cover	X1
Ⓖ		Right Back Frame	X1
Ⓕ		Left Arm	X1
Ⓖ		Right Arm	X1

POWER SOFA RECLINER

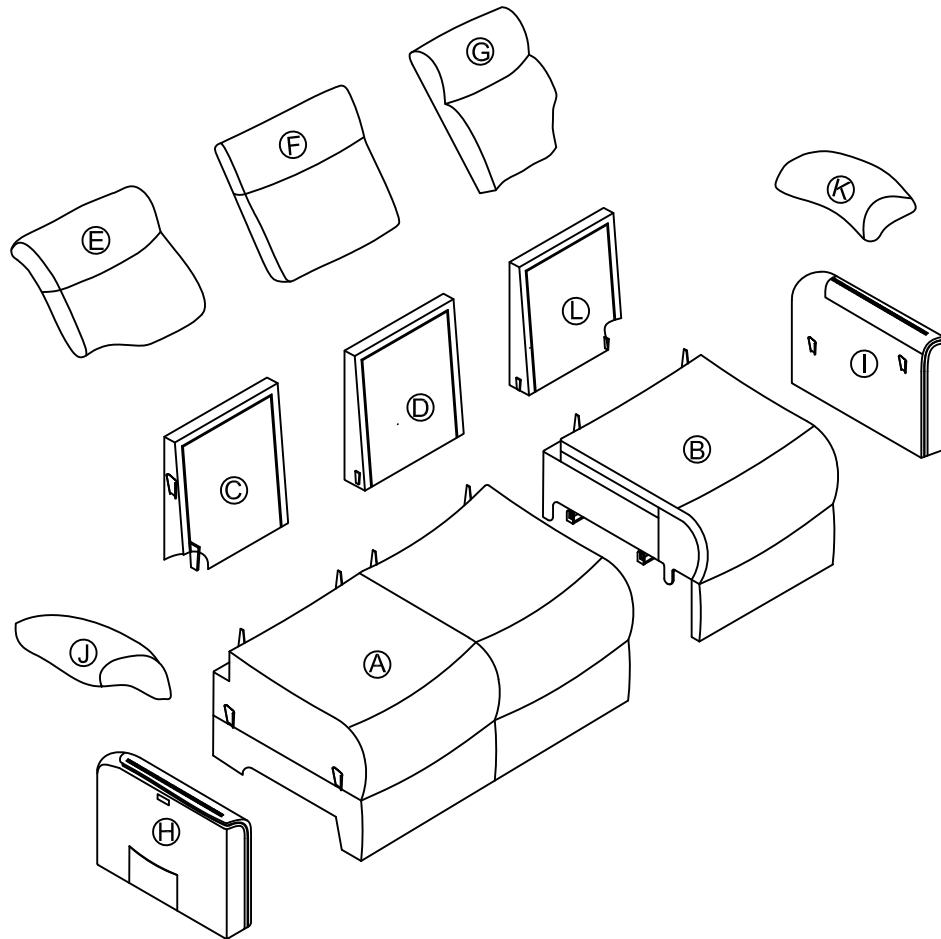

Hardware parts

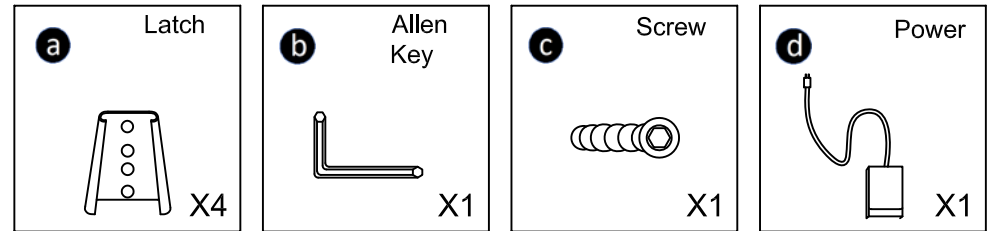

Main structure accessories

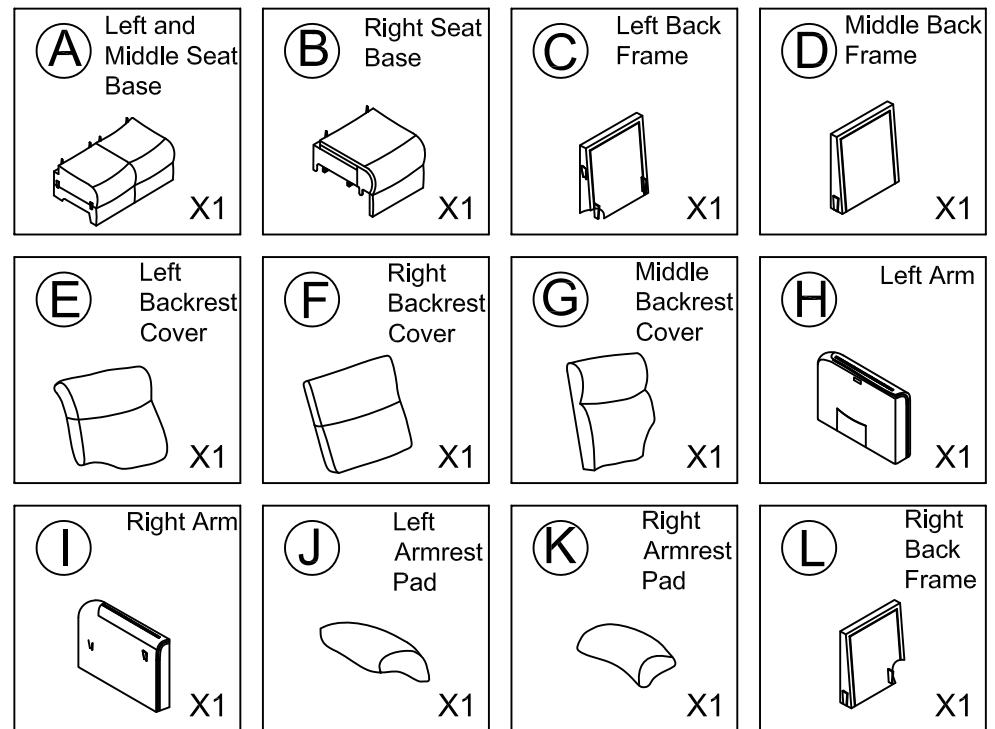

STEP 1

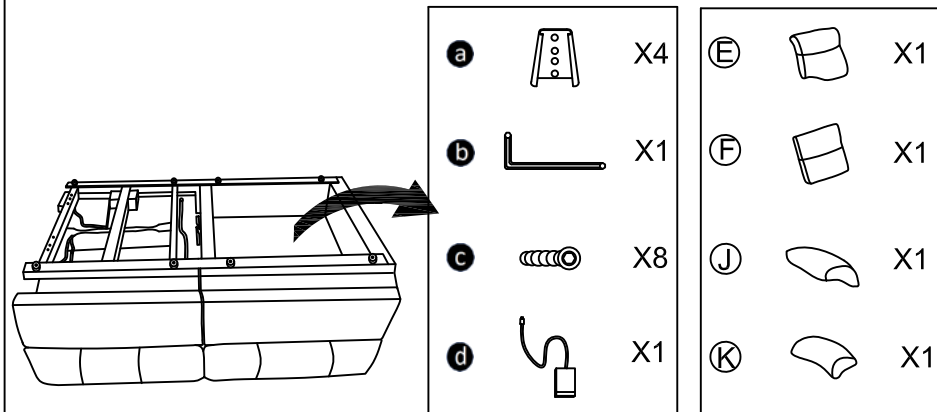

Taking out of Left and middle backrest cover, armrest pat and hardwares from the bottom

STEP 2

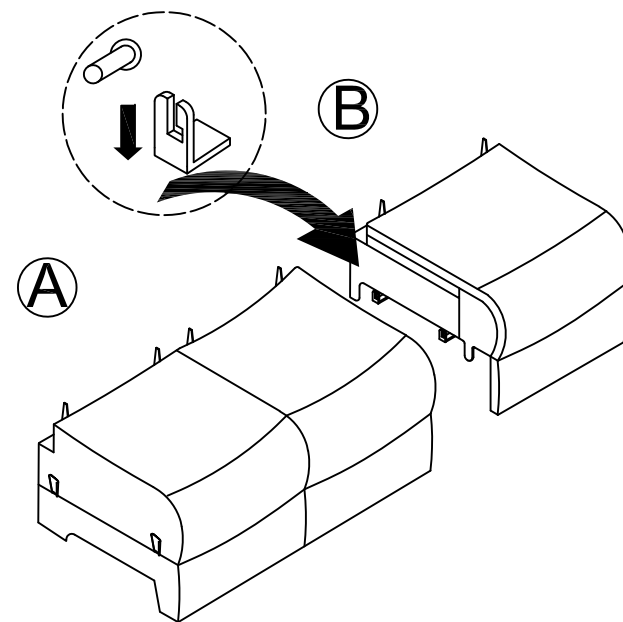

STEP 3

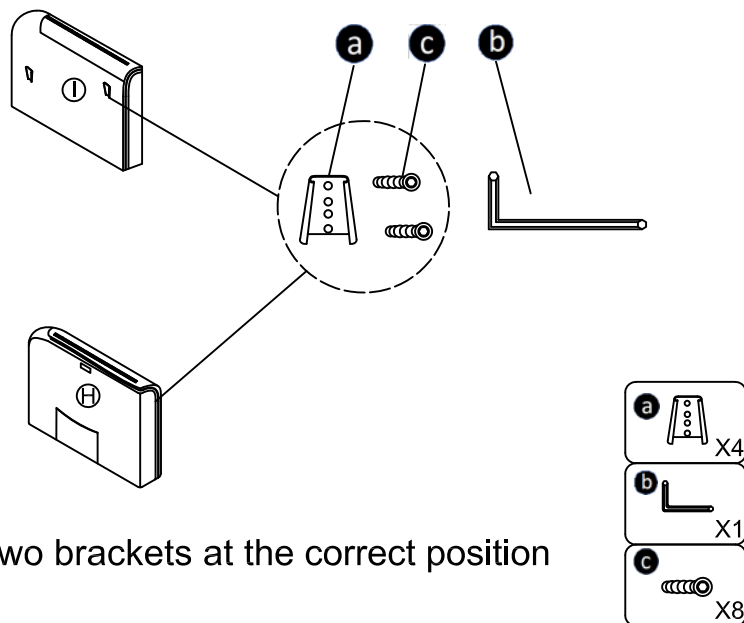

Fastening two brackets at the correct position of the arm

STEP 4

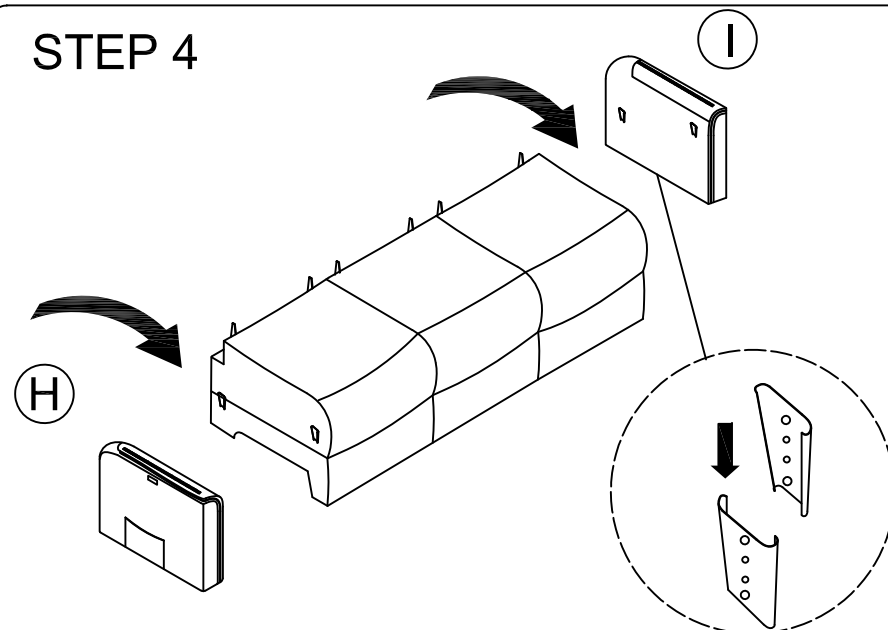

Connect with the seat base

STEP 5

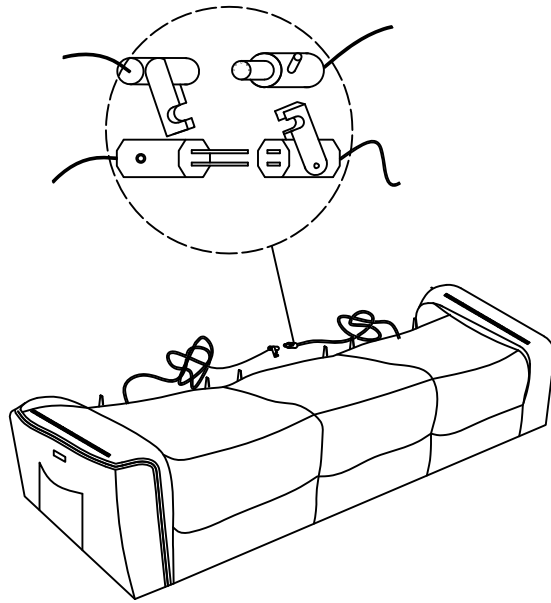

Connecting cable at the bottom

STEP 6

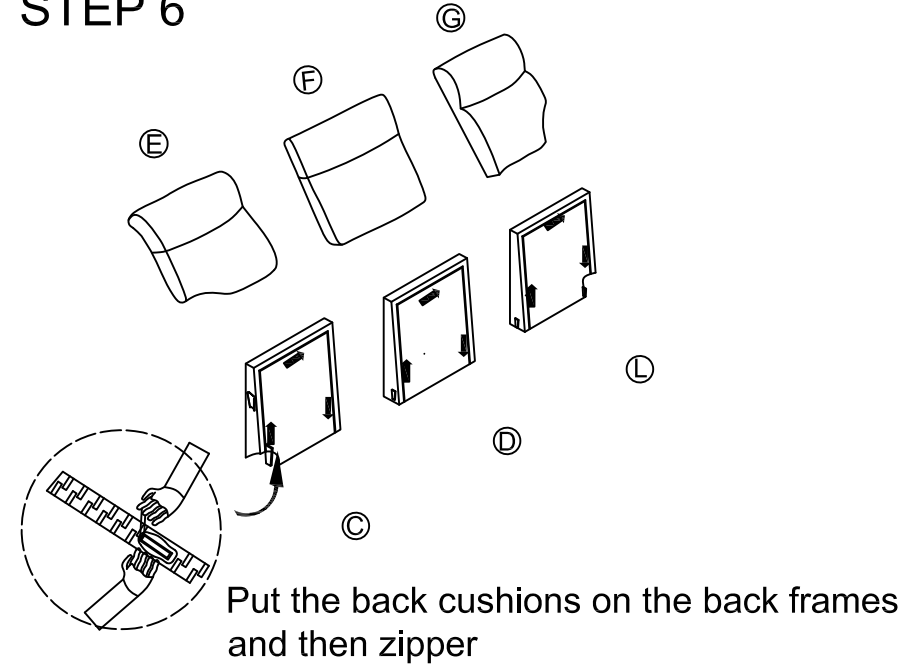

STEP 7

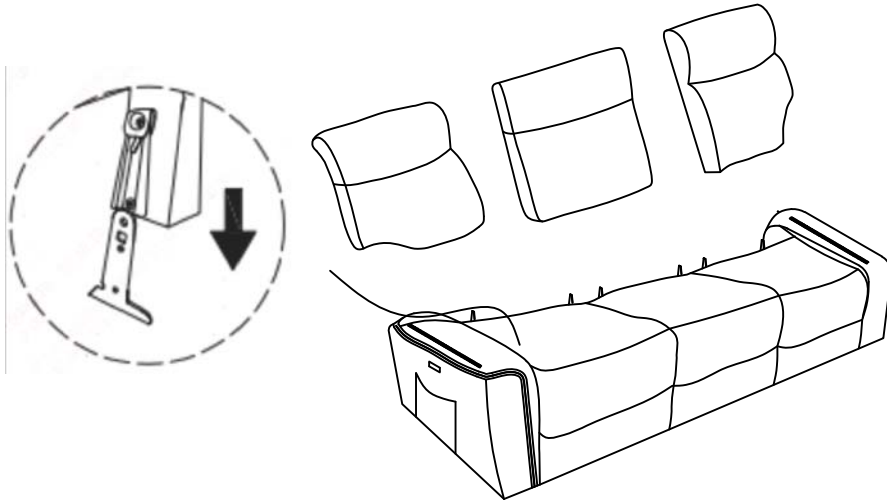

STEP 8

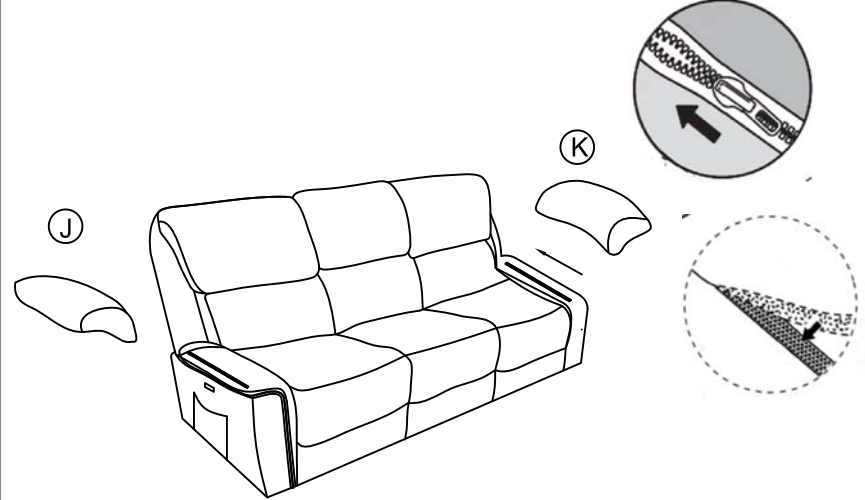

Using nylon fastener to secure it in place

STEP 9

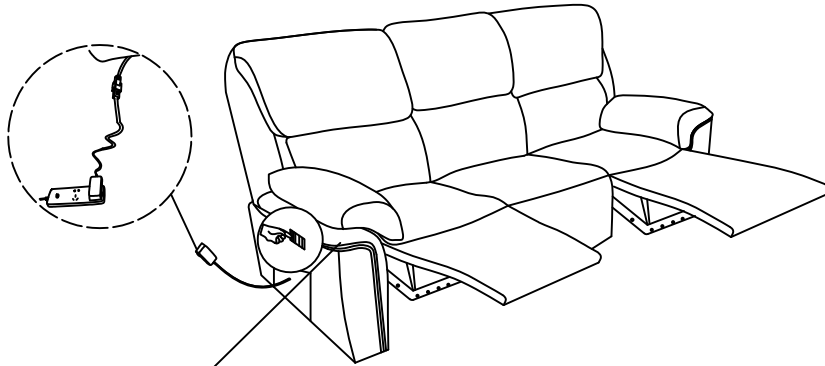

Turn on

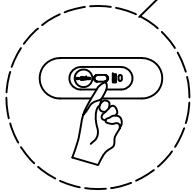

Turn off

STEP 10

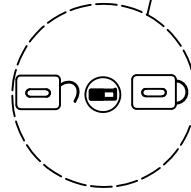
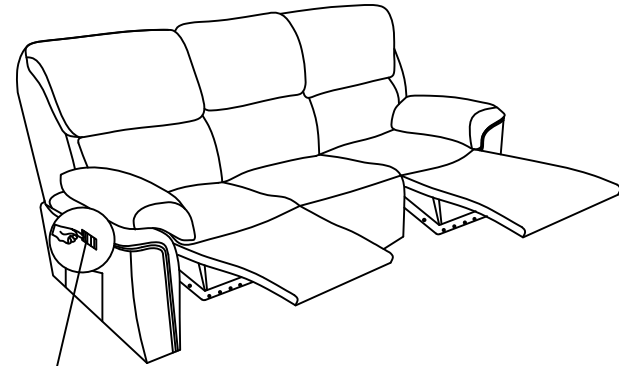

Child lock

STEP 11

