

# ASSEMBLY INSTRUCTIONS

---

## Wood Platform Bed (BSW008-F)



### **Dear Customers,**

Thank you for purchasing our product. Please read this instruction manual carefully after receiving this product. It will help you assemble this product quickly, safely and correctly. You can keep this manual for future reference.

## ! IMPORTANT

Please follow the instruction manuals and use a pad to protect the product during your assembly.

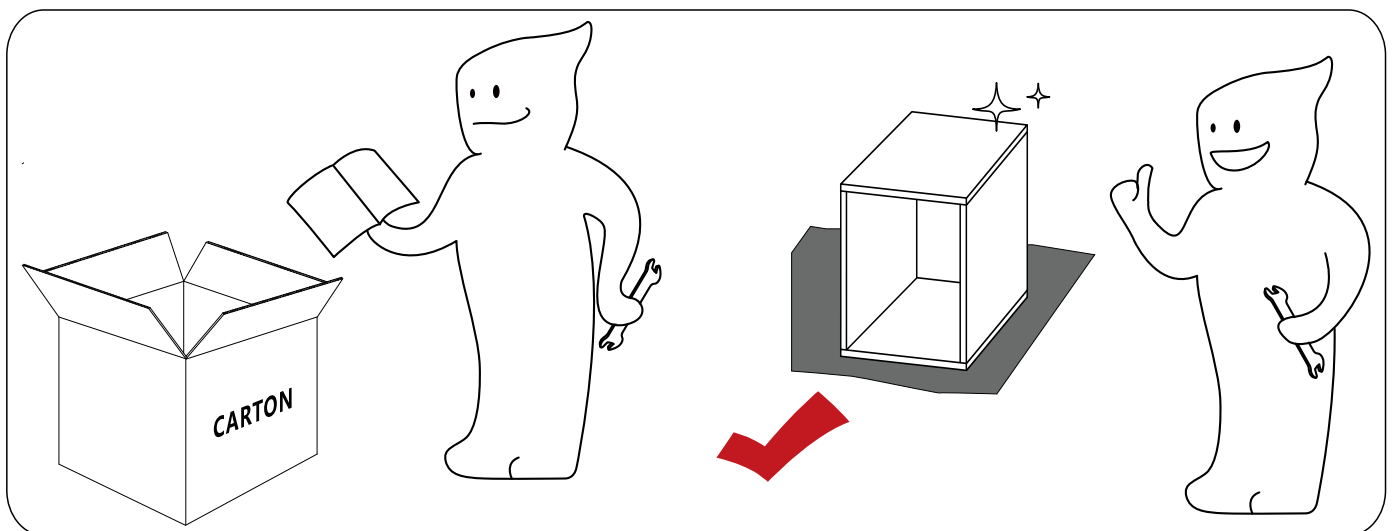
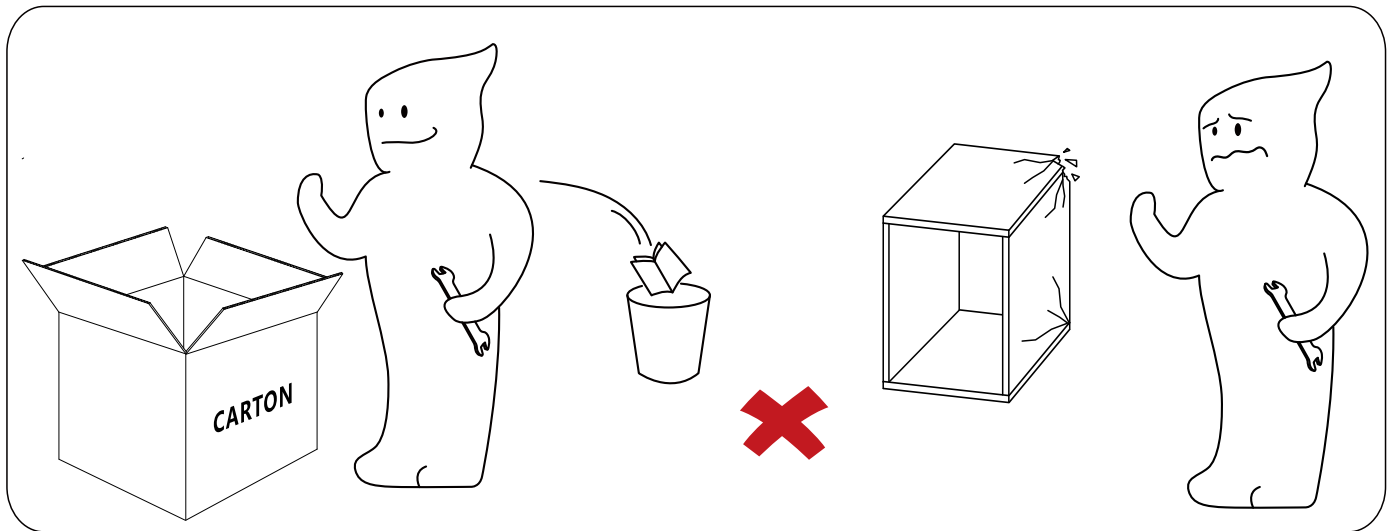

**Note:**

- 1. Should be assembled on flat ground to keep balance.**
- 2. Before completing the installation, do not tighten the screws.**







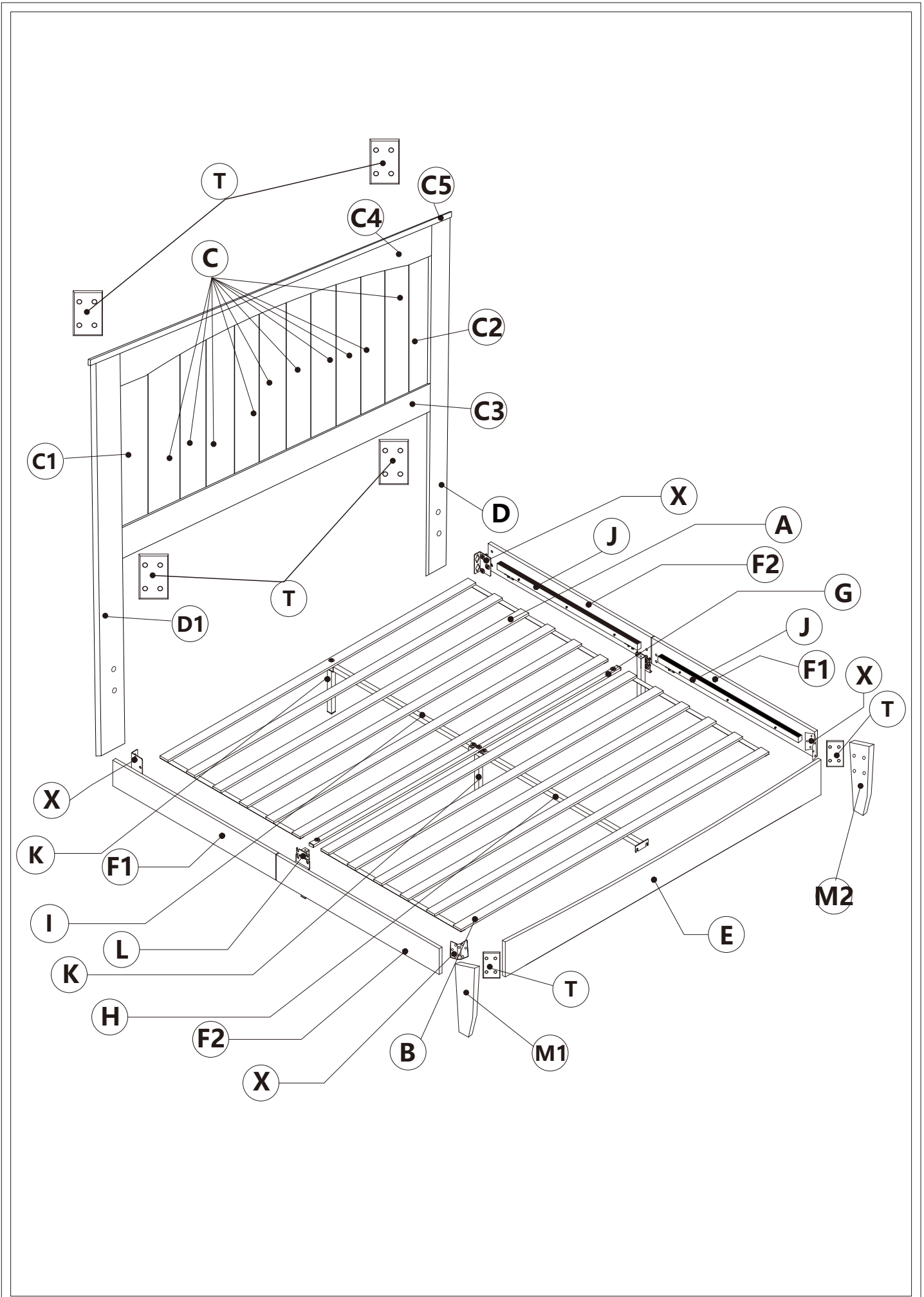

For easier and better assembly, **2** or more adults are required.

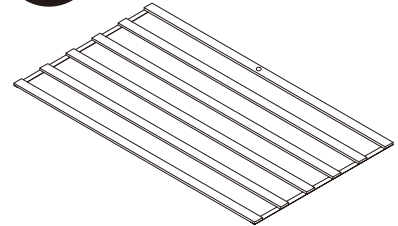
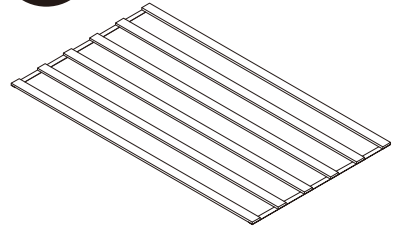
# ASSEMBLY INSTRUCTIONS

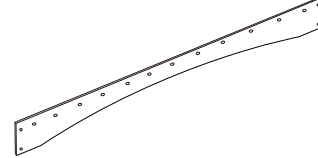
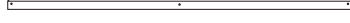
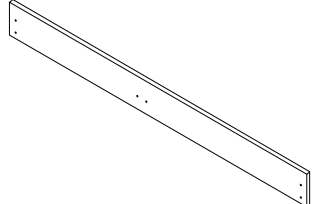

# ASSEMBLY INSTRUCTIONS

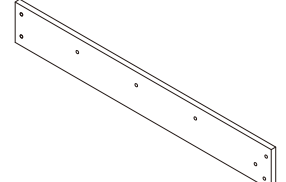
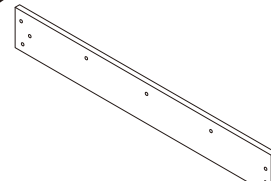
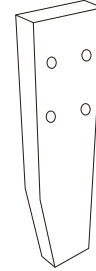
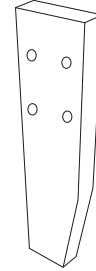
<p><b>(A)</b></p>  <p>1 pc</p>	<p><b>(B)</b></p>  <p>1 pc</p>	<p><b>(C)</b></p>  <p>10 pcs</p>
<p><b>(C1)</b></p>  <p>1 pc</p>	<p><b>(C2)</b></p>  <p>1 pc</p>	<p><b>(C3)</b></p>  <p>1 pc</p>
<p><b>(C4)</b></p>  <p>1 pc</p>	<p><b>(C5)</b></p>  <p>1 pc</p>	<p><b>(E)</b></p>  <p>1 pc</p>
<p><b>(D)</b></p>  <p>1 pc</p>	<p><b>(D1)</b></p>  <p>1 pc</p>	<p><b>(F1)</b></p>  <p>2 pcs</p>
<p><b>(F2)</b></p>  <p>2 pcs</p>	<p><b>(M1)</b></p>  <p>1 pc</p>	<p><b>(M2)</b></p>  <p>1 pc</p>

# ASSEMBLY INSTRUCTIONS

**G**

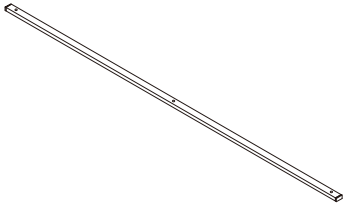

1pc

**H**

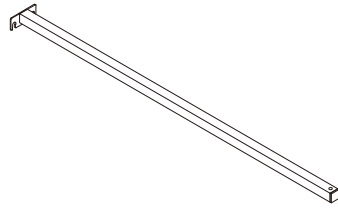

1pc

**I**

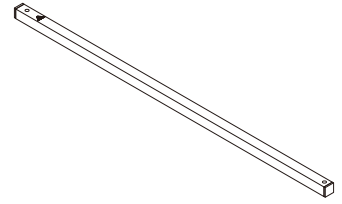

1pc

**J**



4pcs

**K**

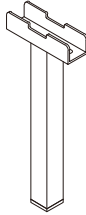





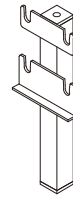

2pcs

**L**

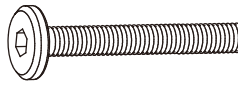
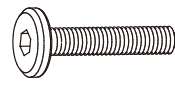

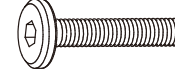
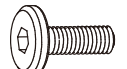
2pcs

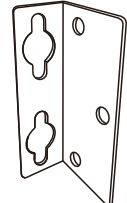
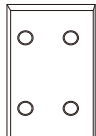
# ASSEMBLY INSTRUCTIONS

<p><b>(N)</b></p>  <p>M6</p> <p style="text-align: right;">1pc</p>	<p><b>(O)</b></p>  <p>M8x50 mm</p> <p style="text-align: right;">1pc</p>	<p><b>(P)</b></p>  <p>M8x35 mm</p> <p style="text-align: right;">5pcs</p>
<p><b>(Q)</b></p>  <p><math>\phi</math> 8x18x1.5 mm</p> <p style="text-align: right;">48pcs+1pc</p>	<p><b>(Q1)</b></p>  <p><math>\phi</math> 6x18x1.5 mm</p> <p style="text-align: right;">50pcs+1pc</p>	<p><b>(R)</b></p>  <p>M8x30 mm</p> <p style="text-align: right;">12pcs</p>
<p><b>(W)</b></p>  <p>M8x14 mm</p> <p style="text-align: right;">30pcs+1pc</p>	<p><b>(S)</b></p>  <p>M6x14 mm</p> <p style="text-align: right;">24pcs+1pc</p>	<p><b>(U)</b></p>  <p>M6x25 mm</p> <p style="text-align: right;">26pcs+1pc</p>
<p><b>(X)</b></p>  <p>100x2 mm</p> <p style="text-align: right;">4pcs</p>	<p><b>(T)</b></p>  <p>70x2 mm</p> <p style="text-align: right;">6pcs</p>	<p><b>(Y)</b></p>  <p style="text-align: right;">4pcs</p>
<p><b>(Y1)</b></p>  <p style="text-align: right;">4pcs</p>		

**1**

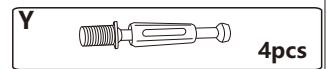
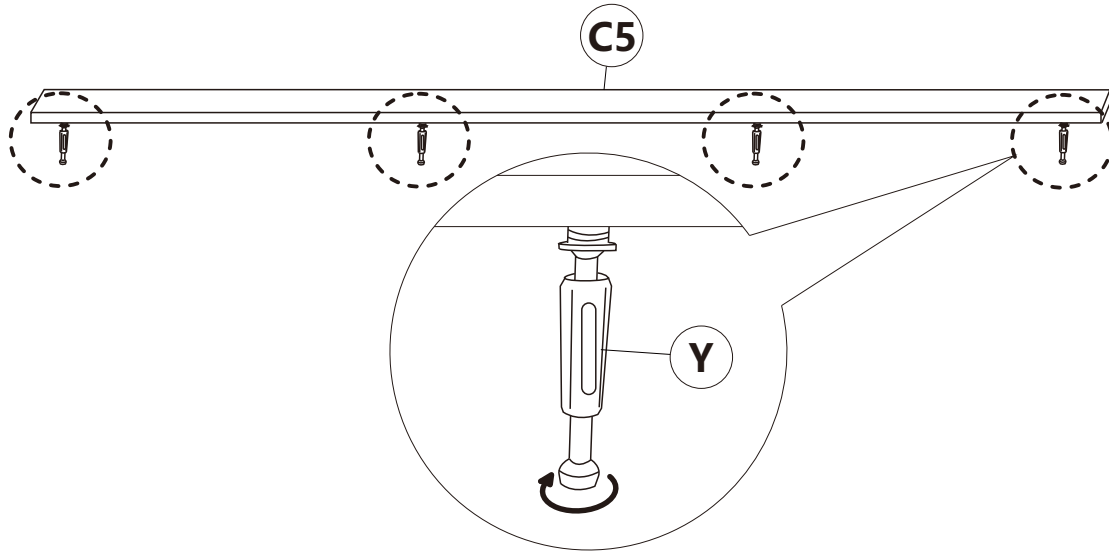

**2**

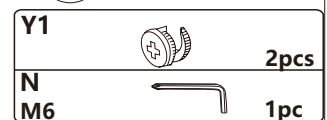
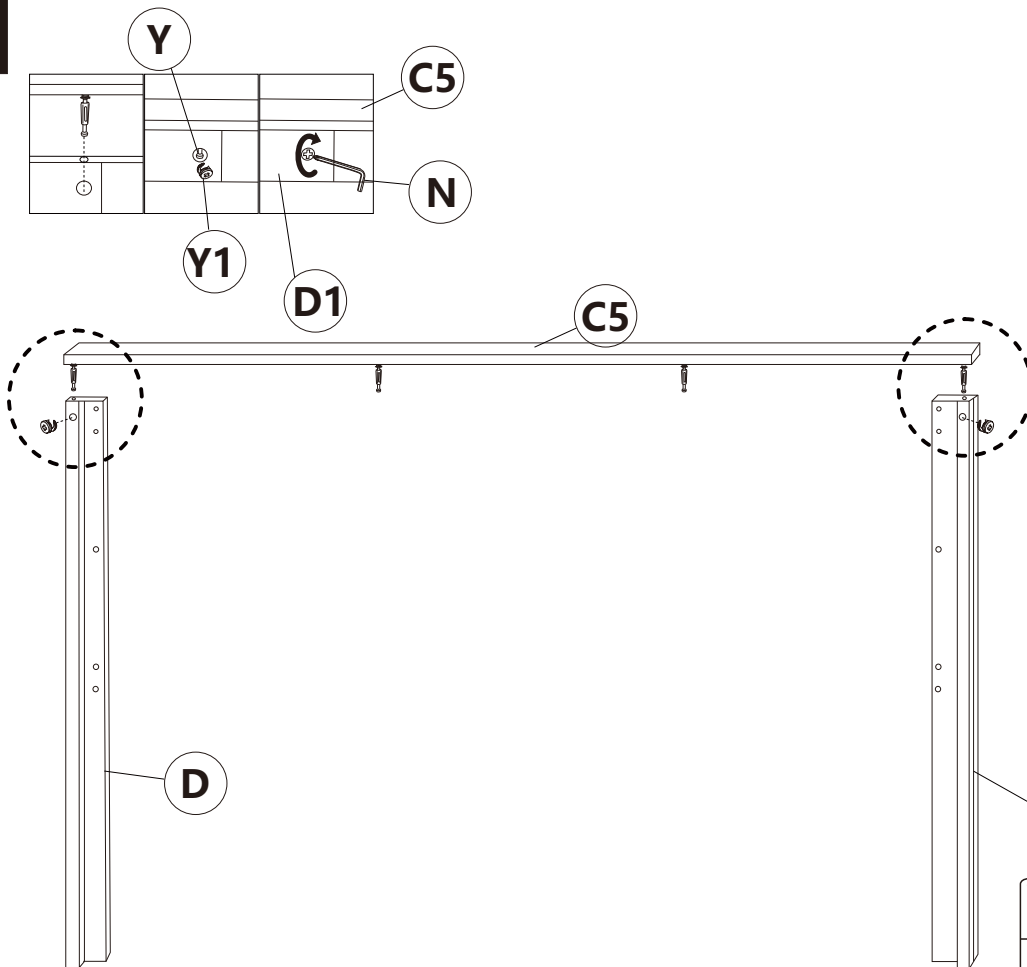

# ASSEMBLY INSTRUCTIONS

**3**

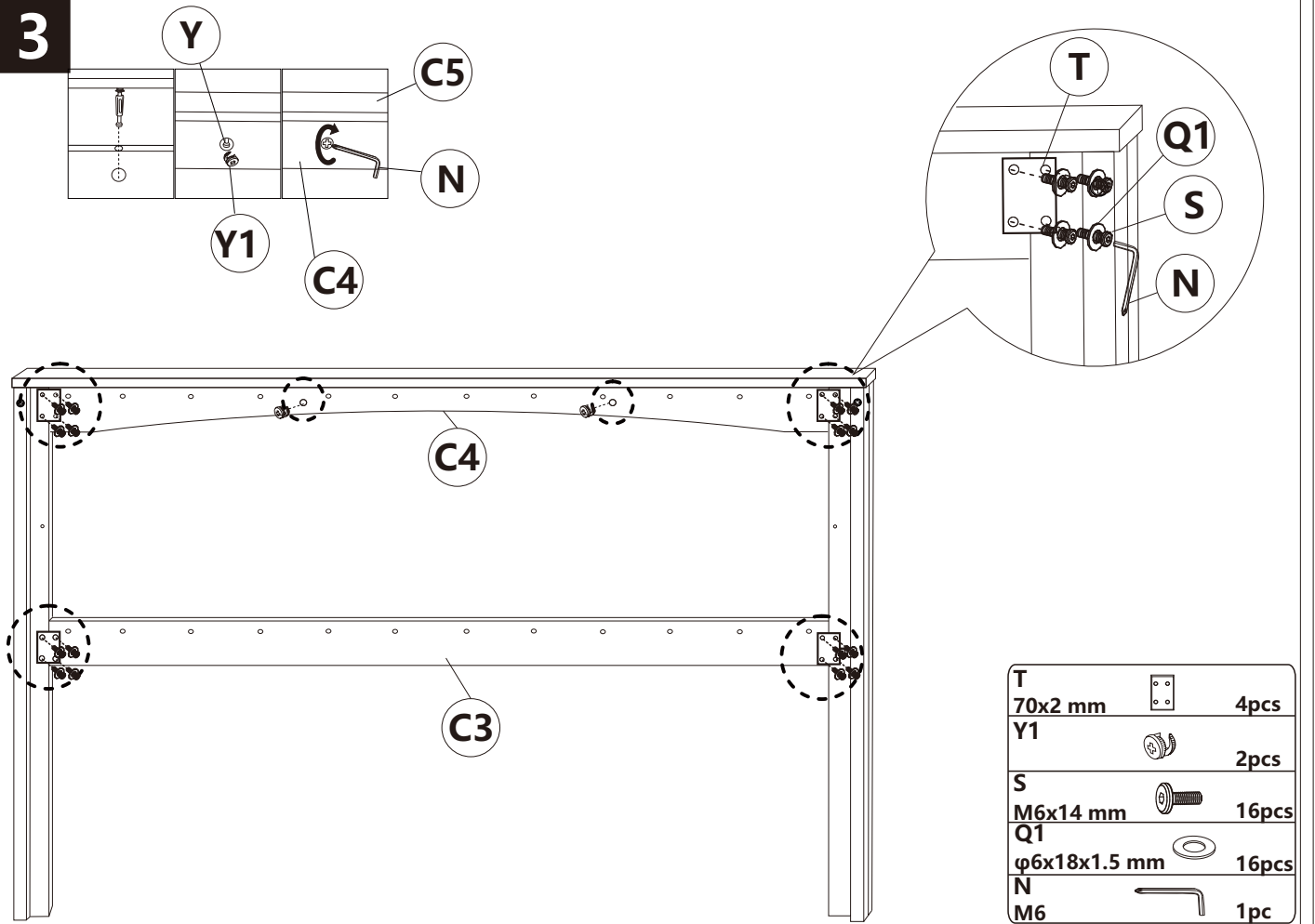

T		4pcs
Y1		2pcs
S		16pcs
Q1		16pcs
N		1pc

**4**

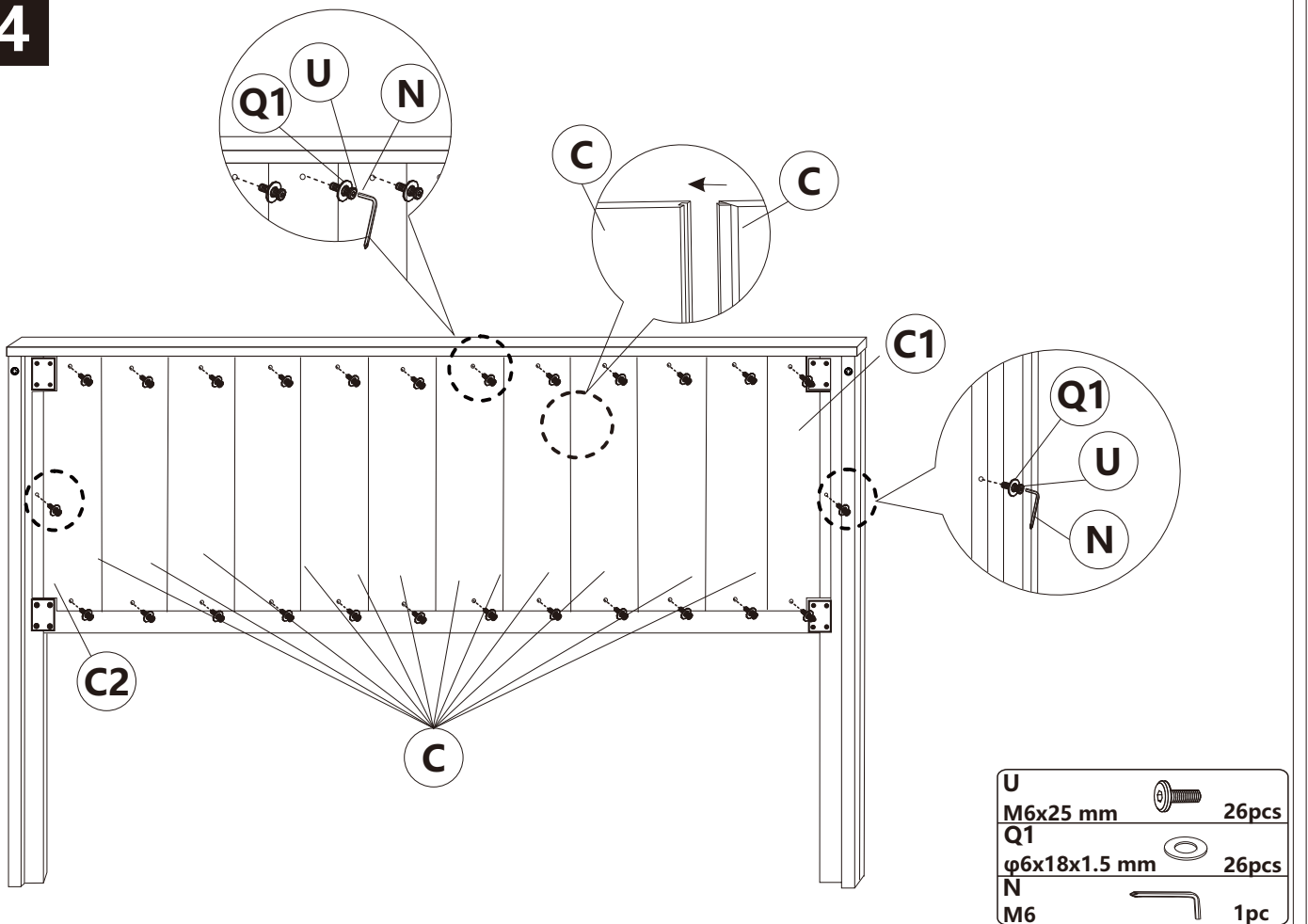



U		26pcs
Q1		26pcs
N		1pc

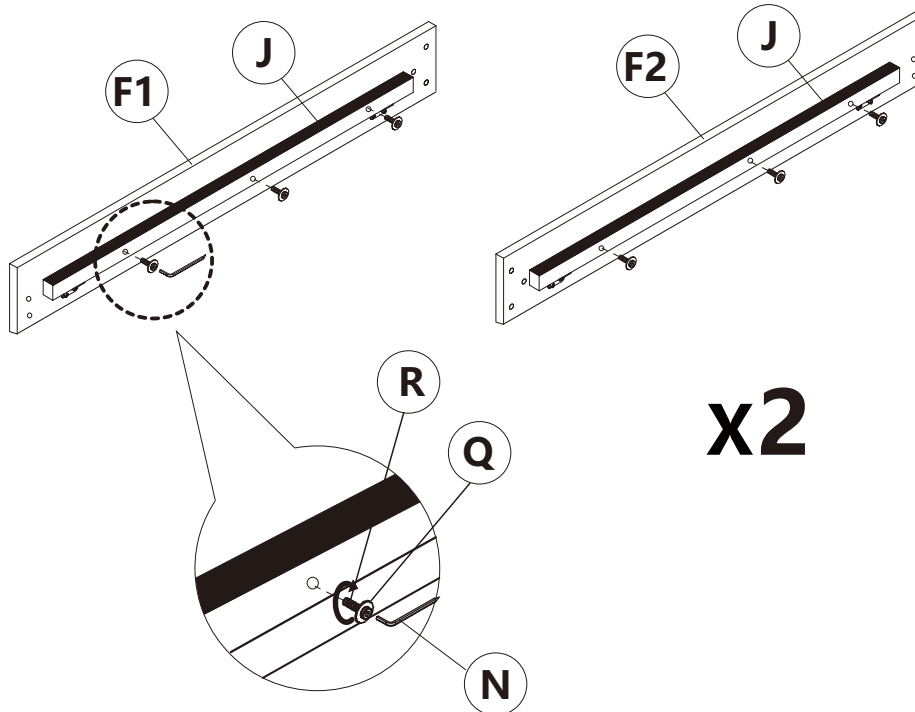

## 5







### x2

R		12pcs
M8x30 mm		
Q		12pcs
φ8x18x1.5 mm		
N		1pc
M6		

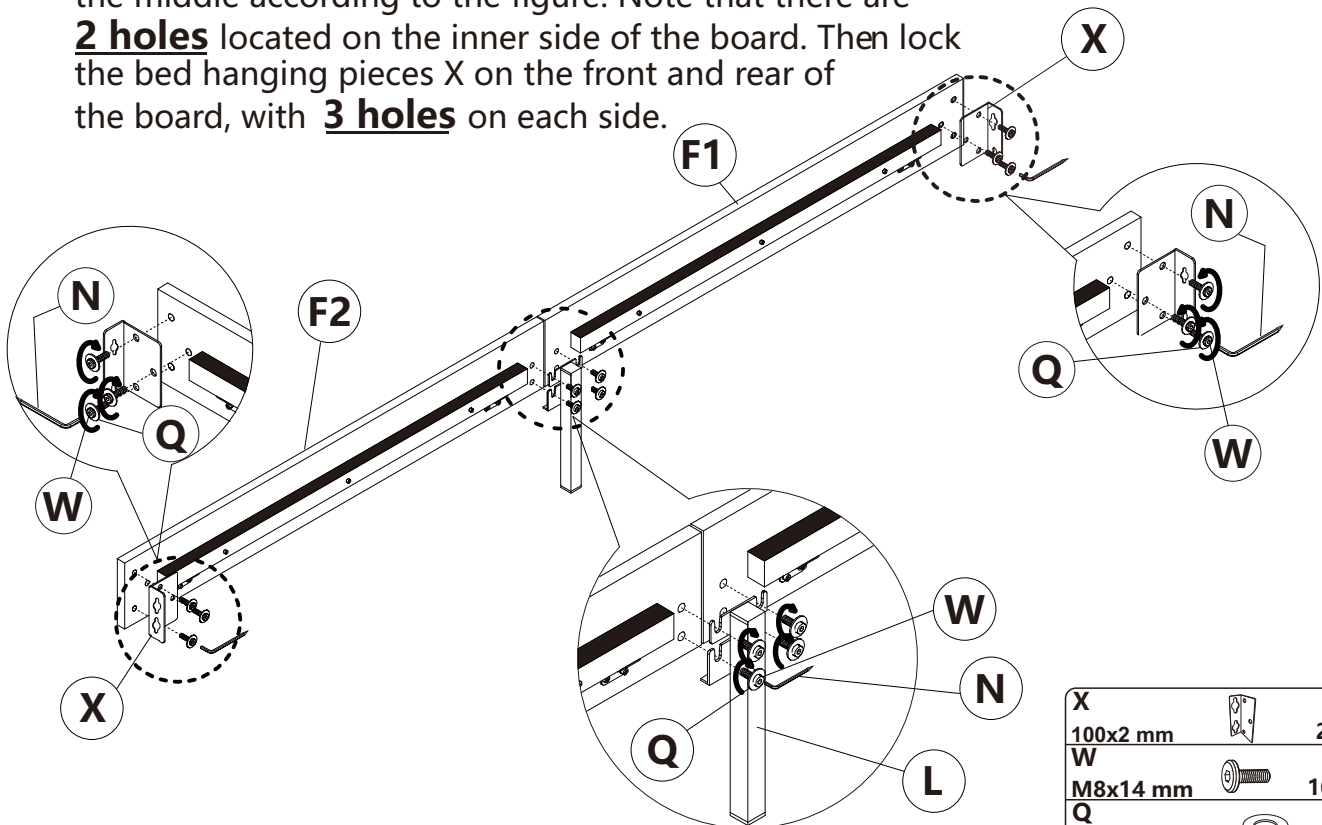
## 6

Take out parts F1 and F2, and lock the iron frame foot L in the middle according to the figure. Note that there are **2 holes** located on the inner side of the board. Then lock the bed hanging pieces X on the front and rear of the board, with **3 holes** on each side.



X		2pcs
100x2 mm		
W		10pcs
M8x14 mm		
Q		10pcs
φ8x18x1.5 mm		
N		1pc
M6		

# ASSEMBLY INSTRUCTIONS

**7** Same as Step 6

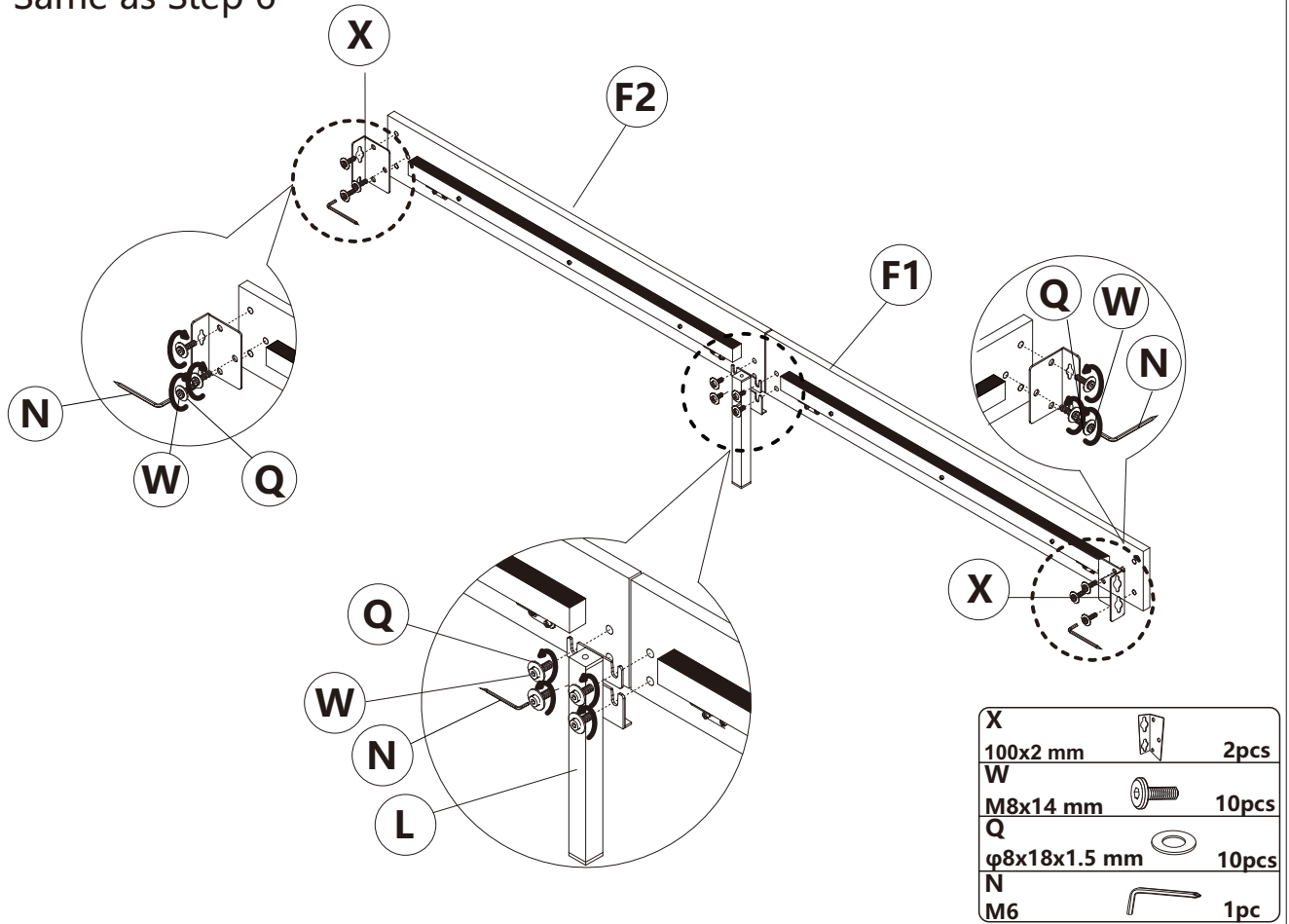

**8** Noted the direction of the arrow on the middle cross beam is pointing to the front.

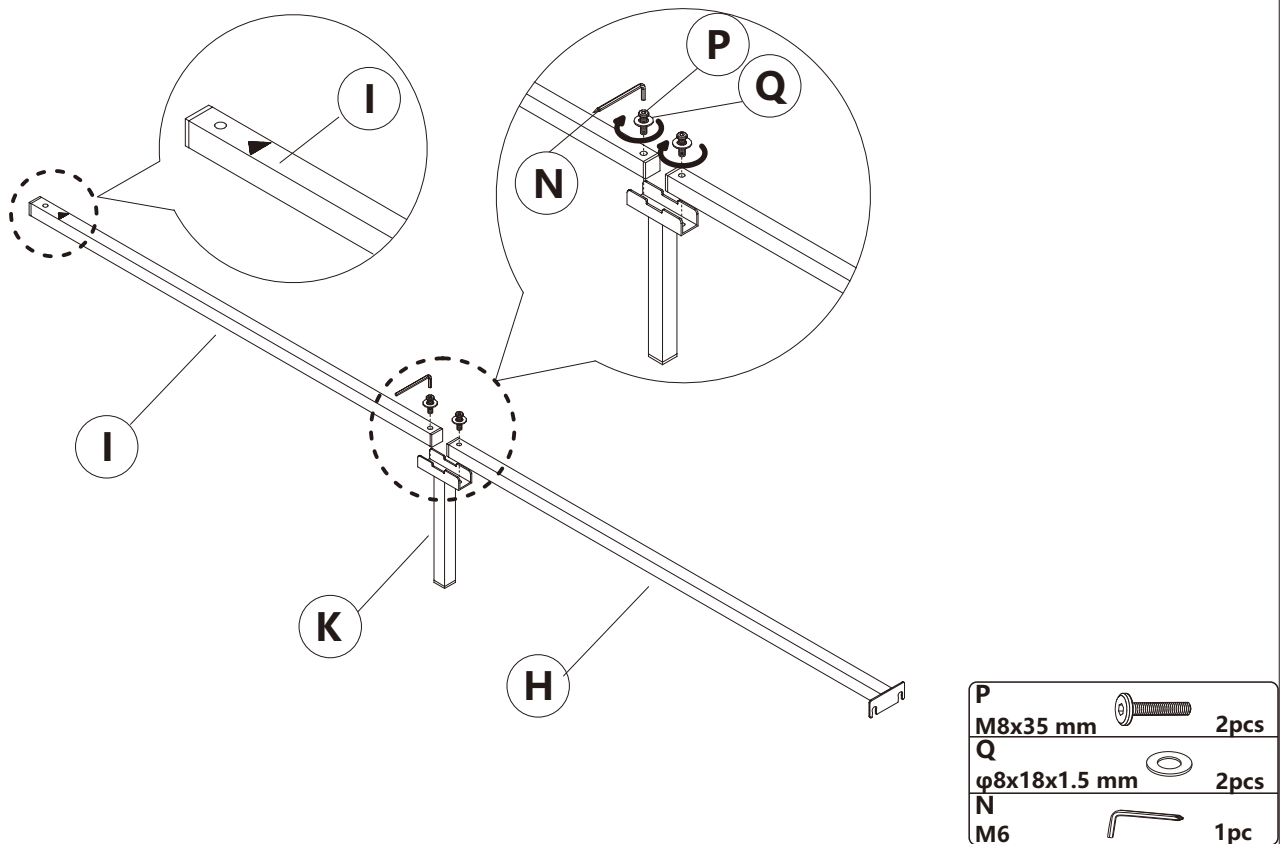

**9**

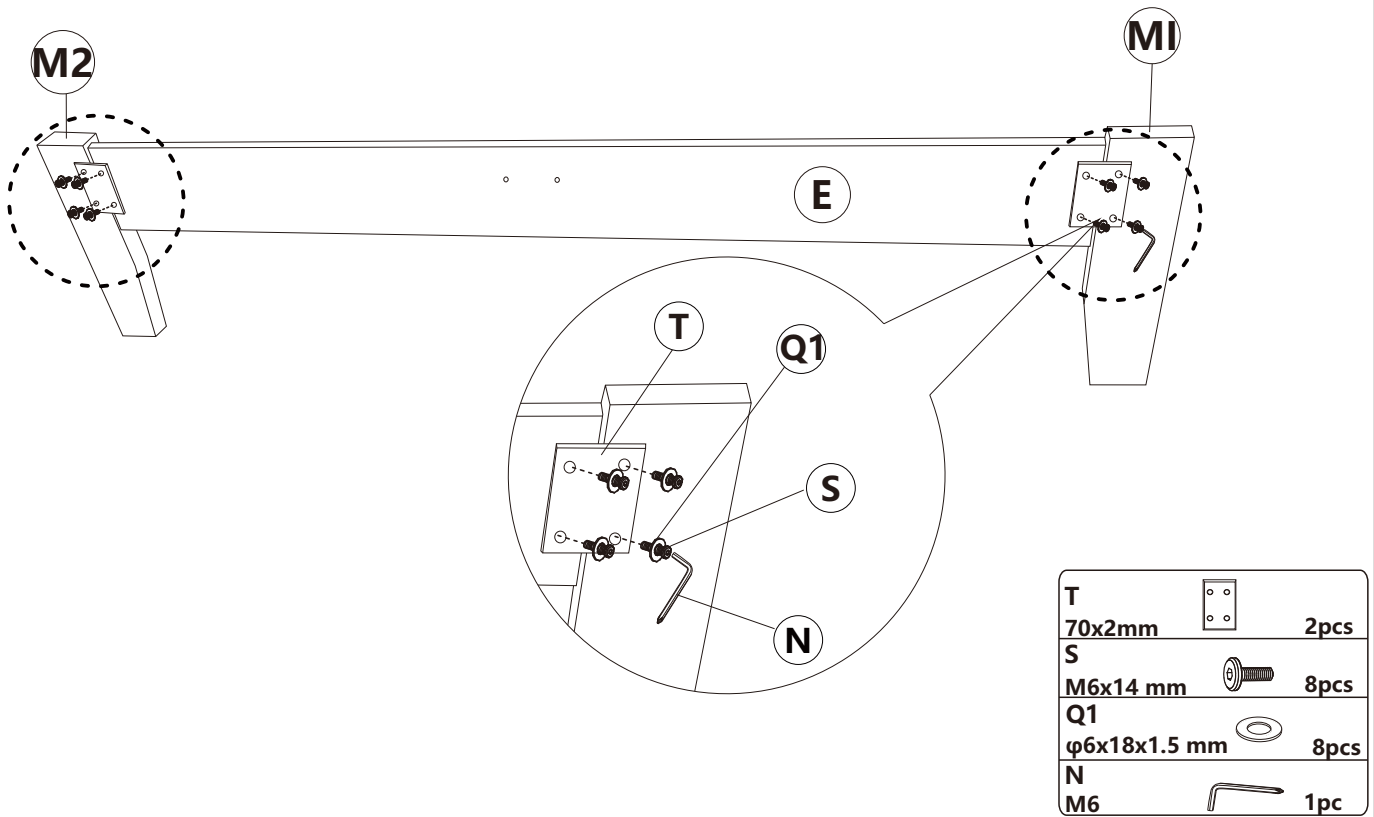



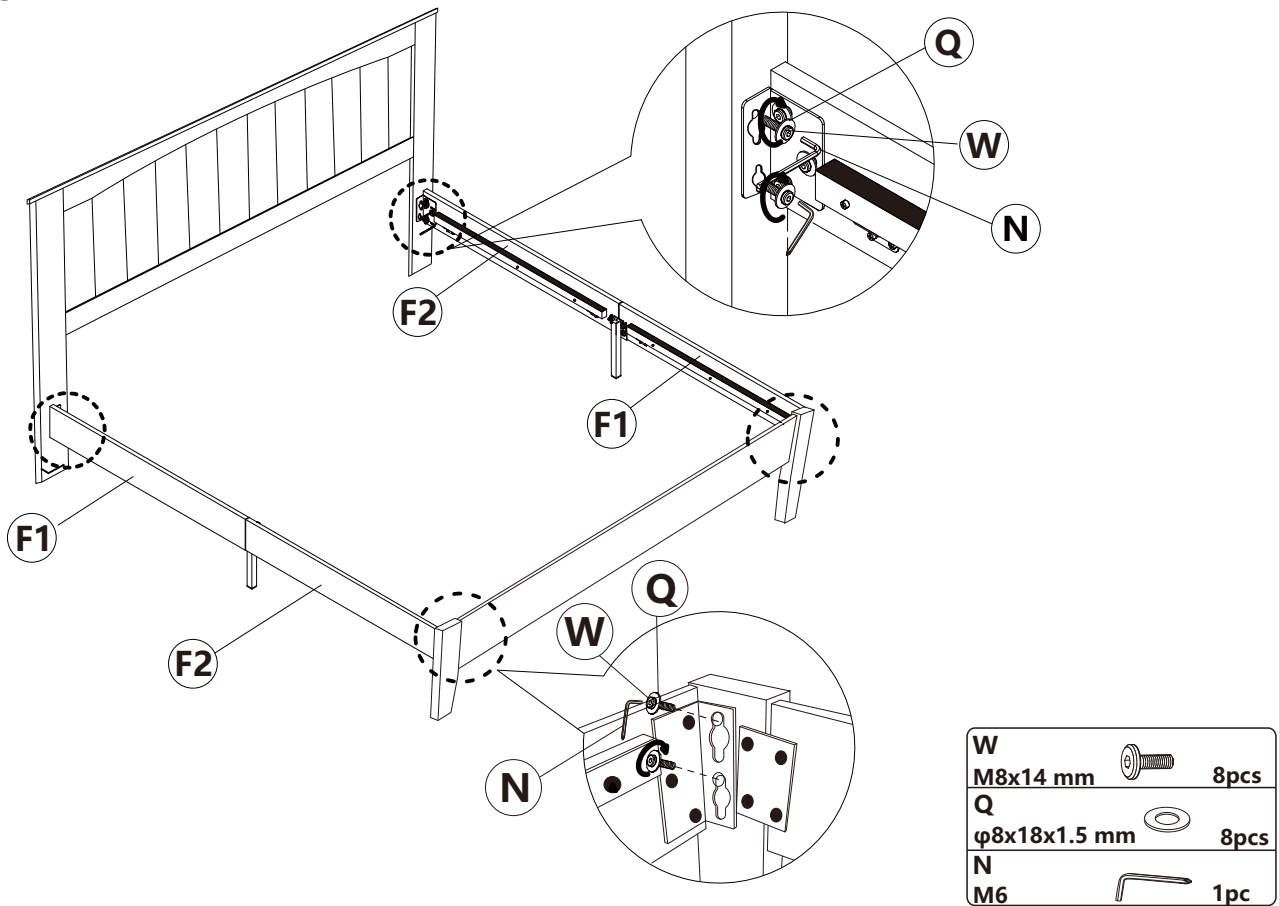

**10** Screw in the screw W to about 50%, then hang the bracket on and finally tighten the screw W.

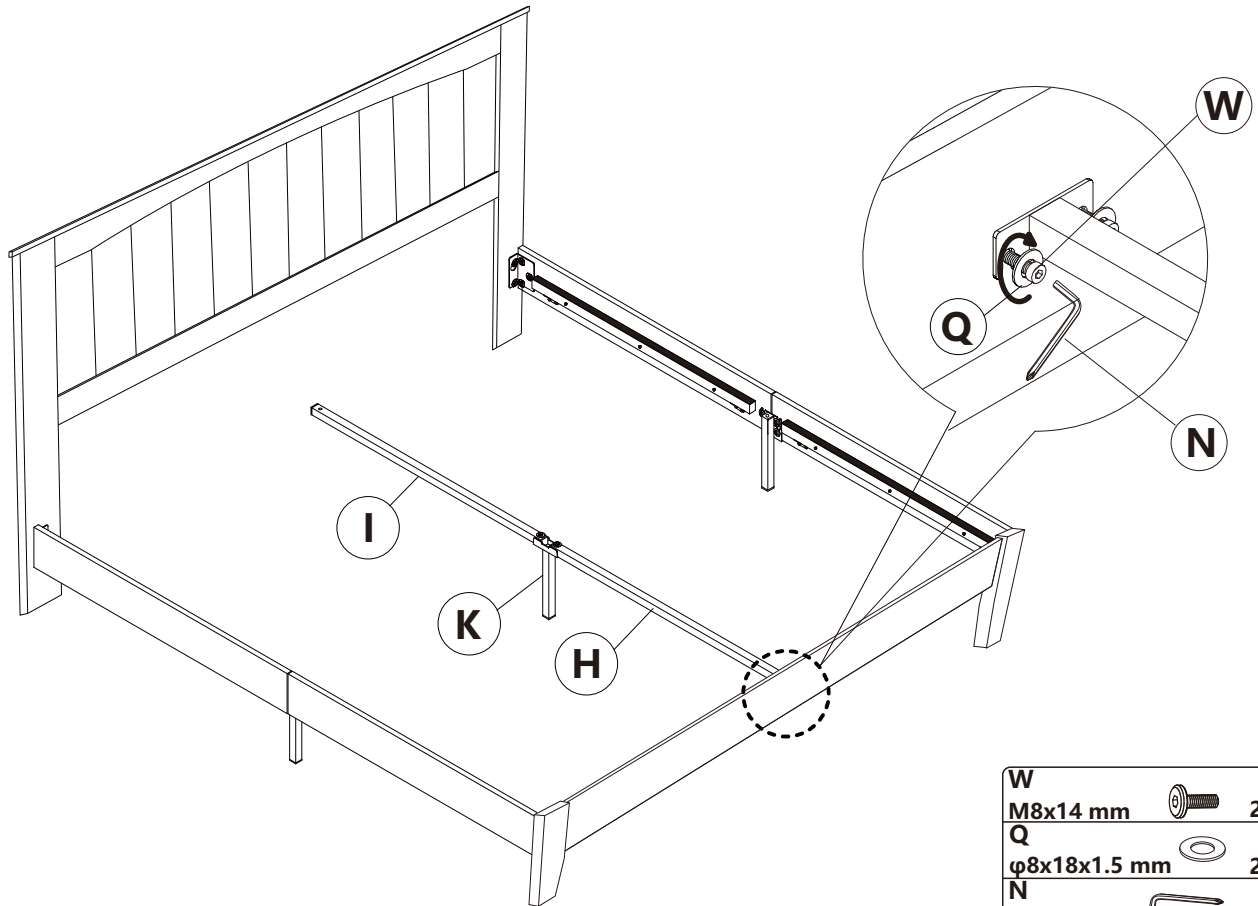

# ASSEMBLY INSTRUCTIONS



11



W		2 pcs
M8x14 mm		
Q		2 pcs
φ8x18x1.5 mm		
N		1 pc
M6		

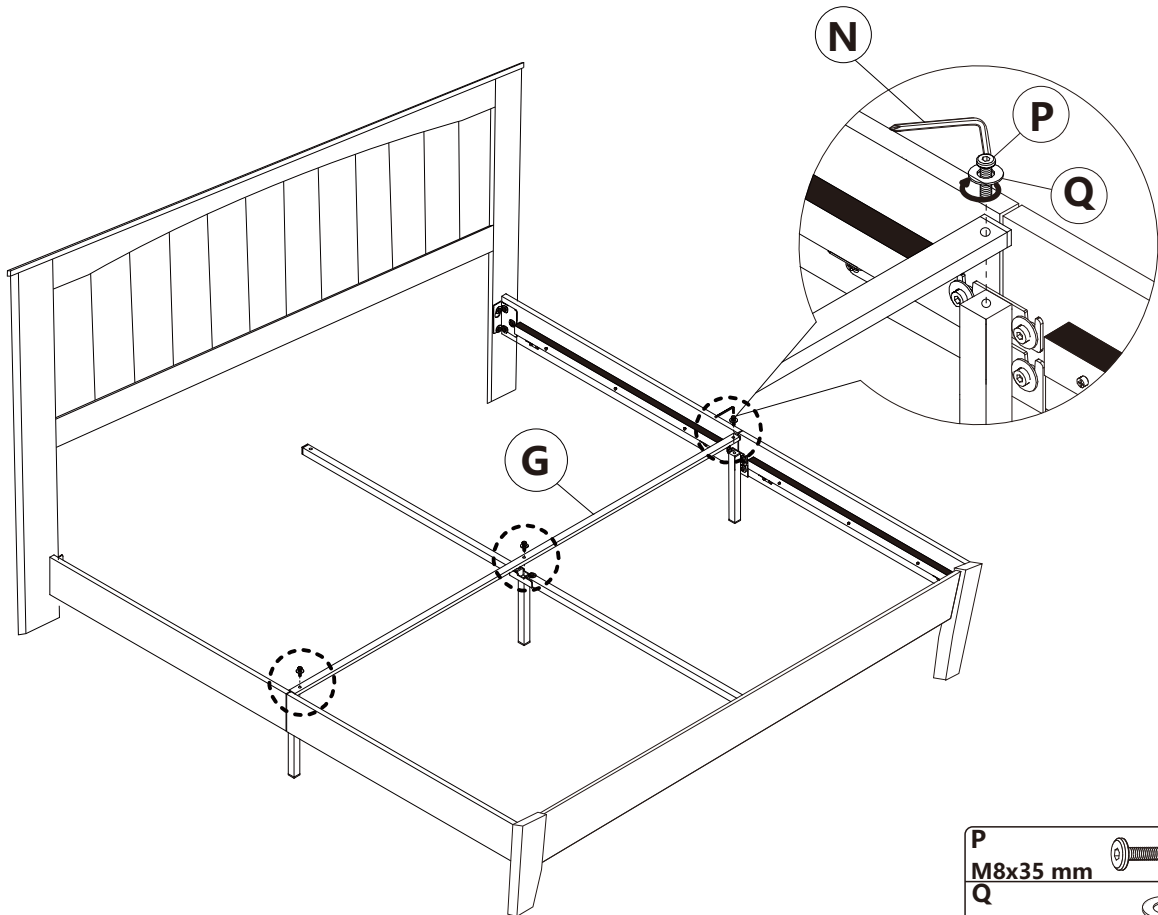

12

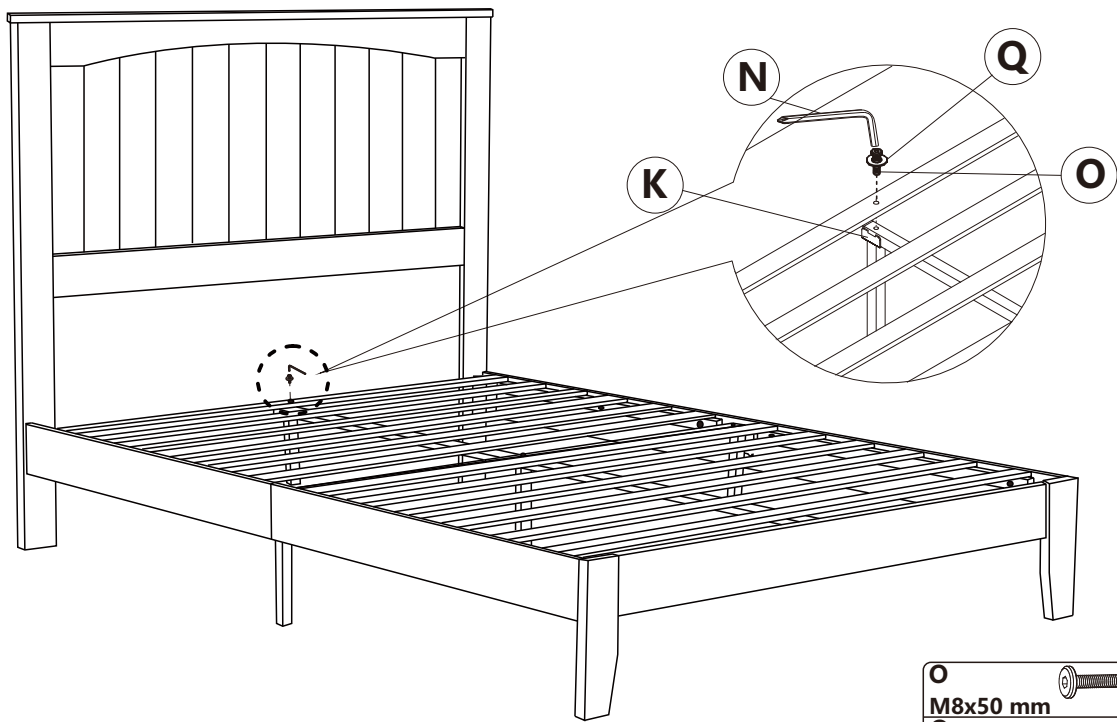

P		3 pcs
M8x35 mm		
Q		3 pcs
φ8x18x1.5 mm		
N		1 pc
M6		

## 13



O		1pc
Q		1pc
N		1pc

## 14

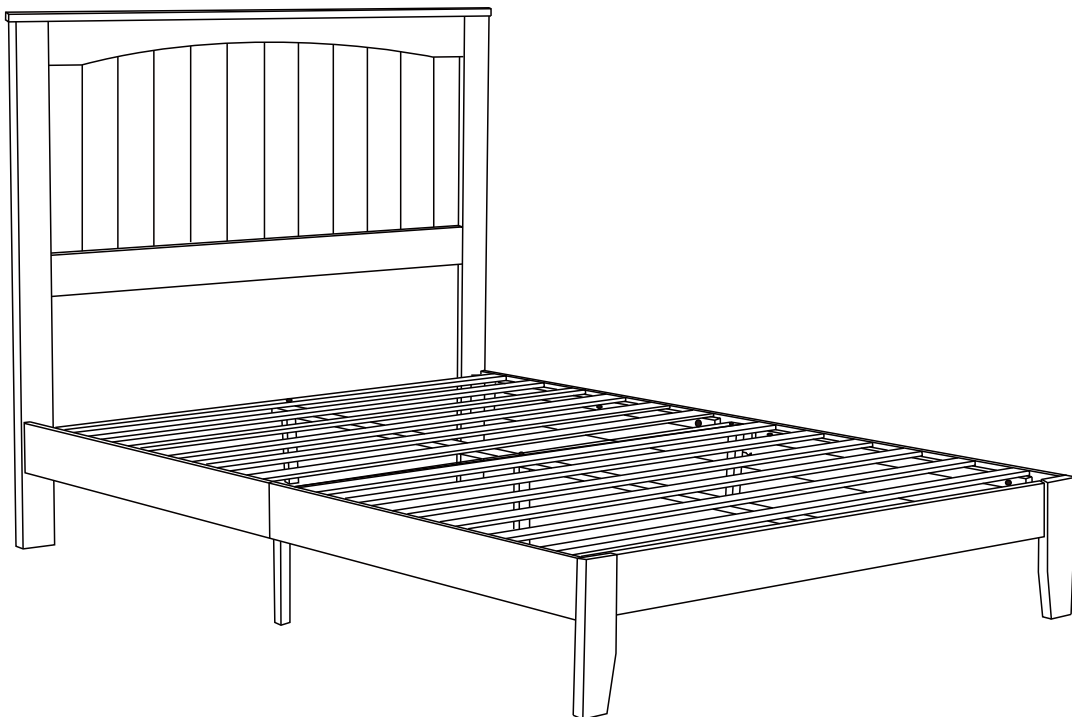

**Installation Complete**