

TV Stand

Assembly Instructions - Please keep for future reference



NOTE:

Comes with TWO PACKAGES with TWO TRACKINGS, may NOT be delivered at the same time.

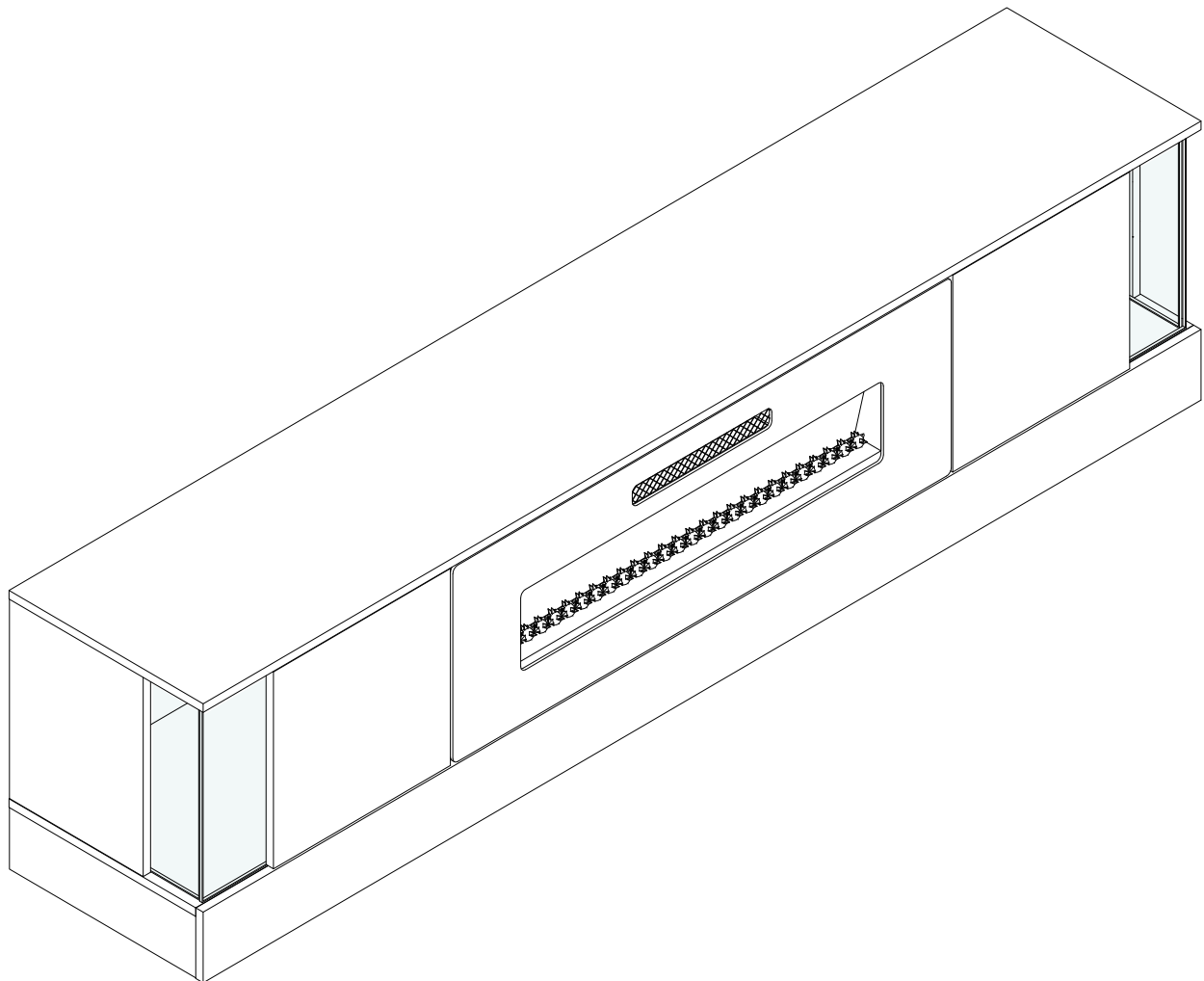

Dimensions

Width - 80 inch
Depth - 15.6inch
Height - 19 inch

Any question please feel free to contact us:
support@amer-life.com TEL:(901) 347-2181
We will provide further assistance within 24 hours.

Important – Please read these instructions fully before starting assembly



Safety and Care Advice

Important – Please read these instructions fully before starting assembly

- Check you have all the components and tools listed on the following pages.
- Remove all fittings from the plastic bags and separate them into their groups.
- Keep children and animals away from the work area, small parts could choke if swallowed.
- Make sure you have enough space to layout the parts before starting.

- During assembly do not stand or put weight on the product, this could cause damage.
- Assemble the item as close to its final position (in the same room) as possible.
- Assemble on a soft level surface to avoid damaging the unit or your floor.
- Parts of the assembly will be easier with 2 people.

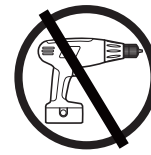

power drill is set on a low torque setting.

- To reduce the likelihood of damaging your product please ensure that your

Care and maintenance

- Only clean using a damp cloth and mild detergent, do not use bleach or abrasive cleaners.
- From time to time check that there are no loose screws on this unit.
- This product should not be discarded with household waste. Take to your local authority waste disposal centre.

Handy Hints

- Assemble all parts and bolts loosely during assembly, only once the product is complete should you fully tighten the bolts
- Regularly check and ensure that all bolts and fittings are tightend properly.

WARNING

In order to help prevent overturning – please follow these instructions

To help prevent product toppling over please follow the steps below:











- Must use the anti tip strap or wall fixing method provided (whichever applies).
- Do not allow children to climb or hang on the furniture.
- Do not place heavy items on top of the furniture, unless the furniture has been designed for this purpose
- Installation shall be carried out exactly according to the instructions - otherwise a safety risk can occur
- In order to prevent falling down this product must be used with the wall attachment device provided.

Please note that only the wall attachment device is provided. You will need to supply wall plugs and screws applicable for your wall type.

Components - Fittings

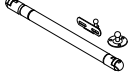
Please check you have all the fittings listed below

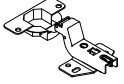
Note: The quantities below are the correct amount to complete the assembly. In some cases more fittings may be supplied than are required.

A  7*43mm Cam Bolt x 30	B  Cam Lock x 30	C  8*30mm Wooden Dowel x 34
D  3.5*14mm Screw x 38	E  5*40mm Screw x 12	F  5*16mm Bolt and Washer x 8
G  Gas strut x 2	H  Protective Foot x 8	I  Push-open Latch x 2
J  Hinge x 4	K  Back Panel Stiffener x 8	

Tools required

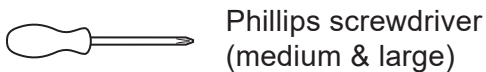

Ruler - Use this ruler to help correctly identify the screws

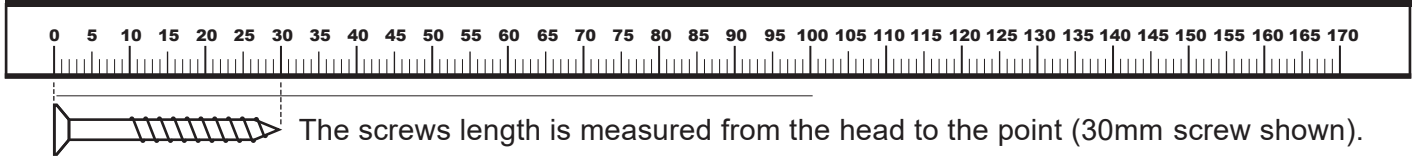

Using Camlocks

Step 1

Connect the male camlock as directed in the assembly instructions using a screwdriver.

1

DO NOT OVER TIGHTEN.
NE PAS SERRER EXCESSIVEMENT.

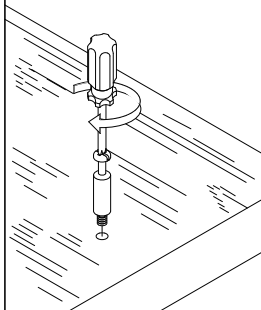

Step 2

Push the male camlock into the entry hole.

2

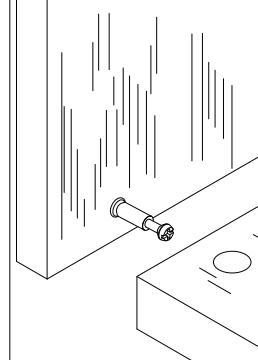

Step 3

Insert the female camlock as shown in the instructions.

Note: ensure that the arrow on the top of the camlock points towards the entry hole for the male camlock.

3

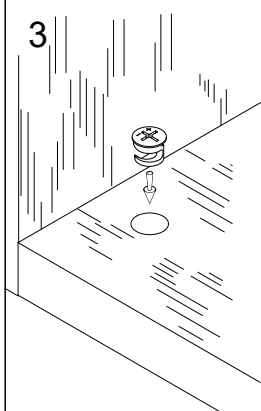

Step 4

Turn the female camlock clockwise with a screwdriver.

You should feel a click when the camlock is locked in place.

The joint is now secure.

4

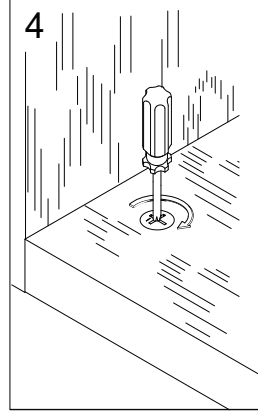

Components - Panels

Please check you have all the panels listed below

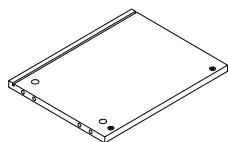

1 (34.8 x 27.2 x 1.5cm) x1

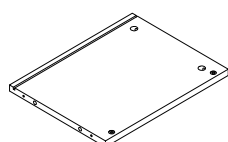

2 (34.8 x 27.2 x 1.5cm) x1

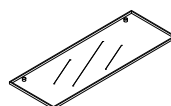

3 (34.4x12.5x 0.5cm) x2

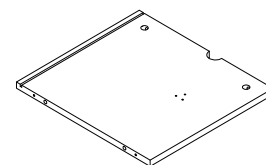

4 (34.8x37.9x 1.5cm) x1

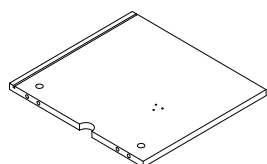

5 (34.8x37.9x 1.5cm) x1

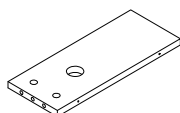

6 (34.8 x 14 x 1.5cm) x2

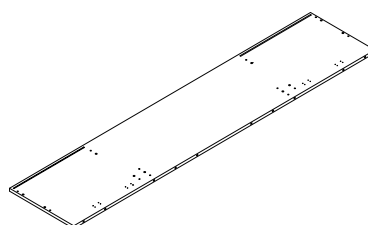

7 (203 x 38 x 1.5cm) x1

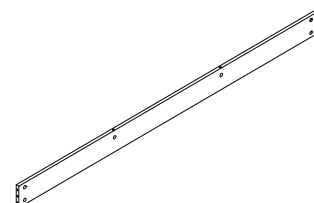

8 (199.8x10.8x 1.5cm) x1

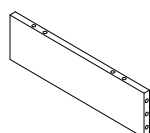

9 (38x10.8x 1.5cm) x1

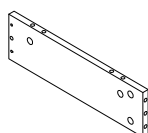

10 (38 x 10.8 x 1.5cm) x1

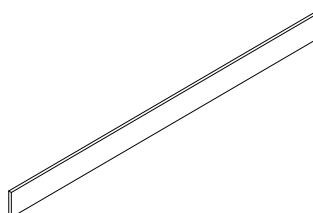

11 (203 x 12.3 x 1.5cm) x1

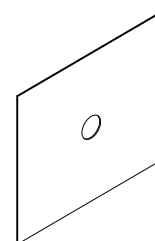

12 (49.2x35.7x 1.5cm) x2

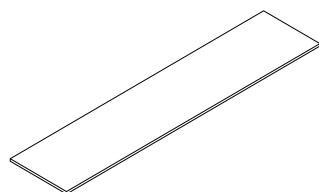

13 (203x39.5x 1.5cm) x1

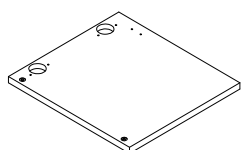

14 (35.9 x 31.3 x 1.5cm) x1

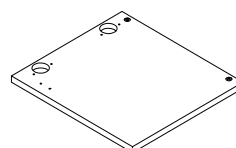

15 (35.9 x 31.3 x 1.5cm) x1

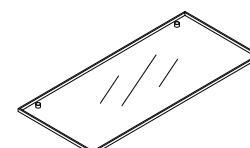

16 (34.4x15.5x 0.5cm) x2

Assembly Instructions

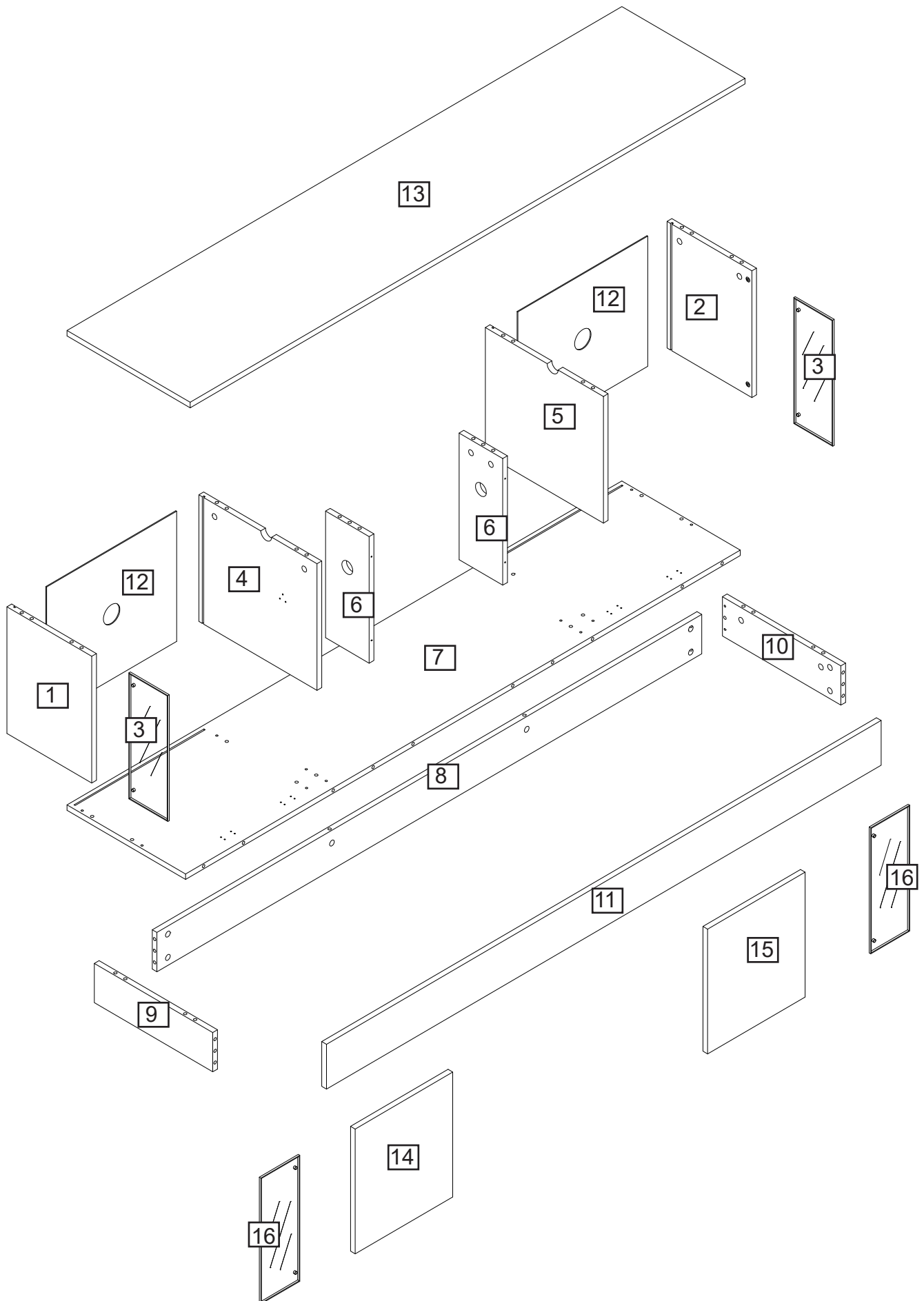

Assembly Instructions

Step 1

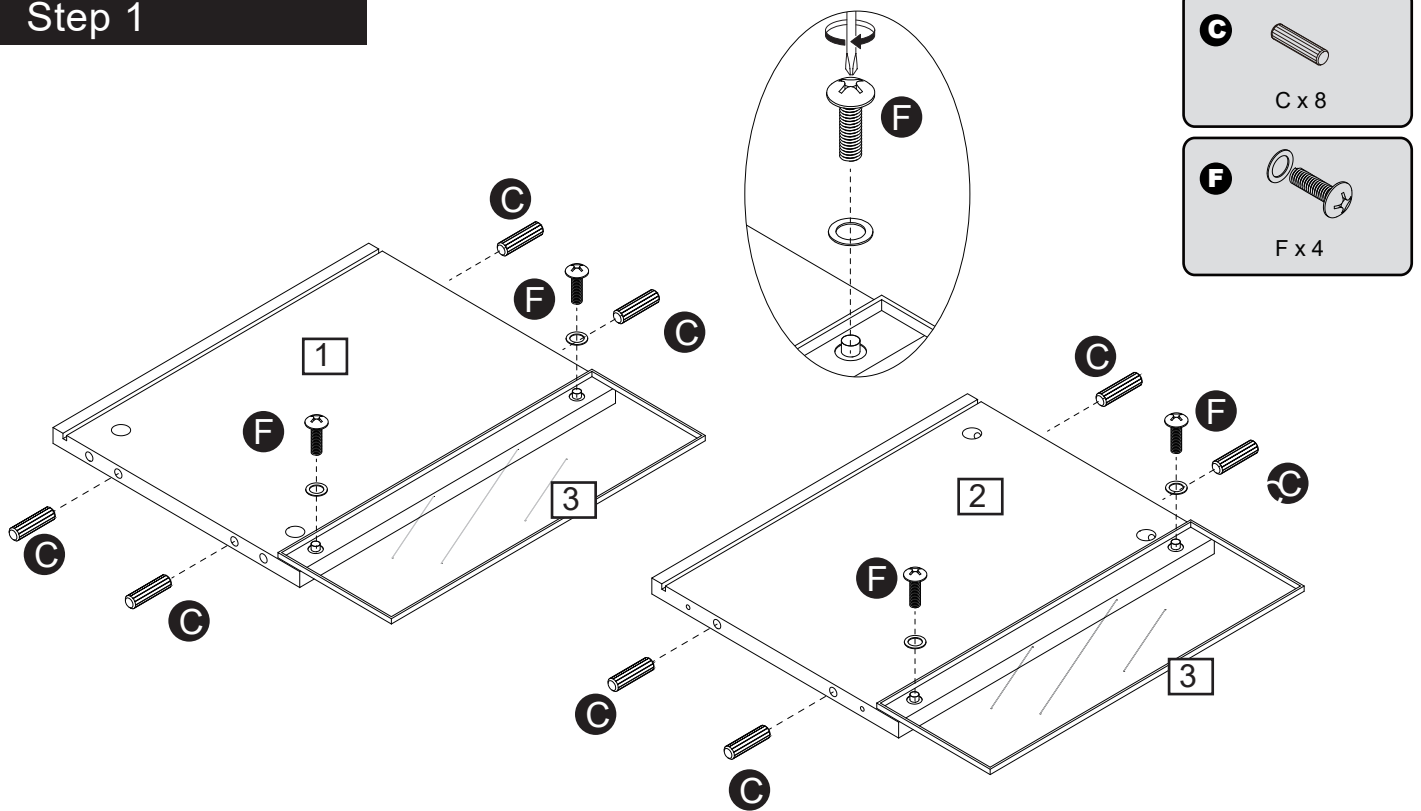

Insert wooden dowel (C) into part (1, 2).
Attach part (3) to part (1, 2) using bolt and washer (F) with a screwdriver.

Step 2

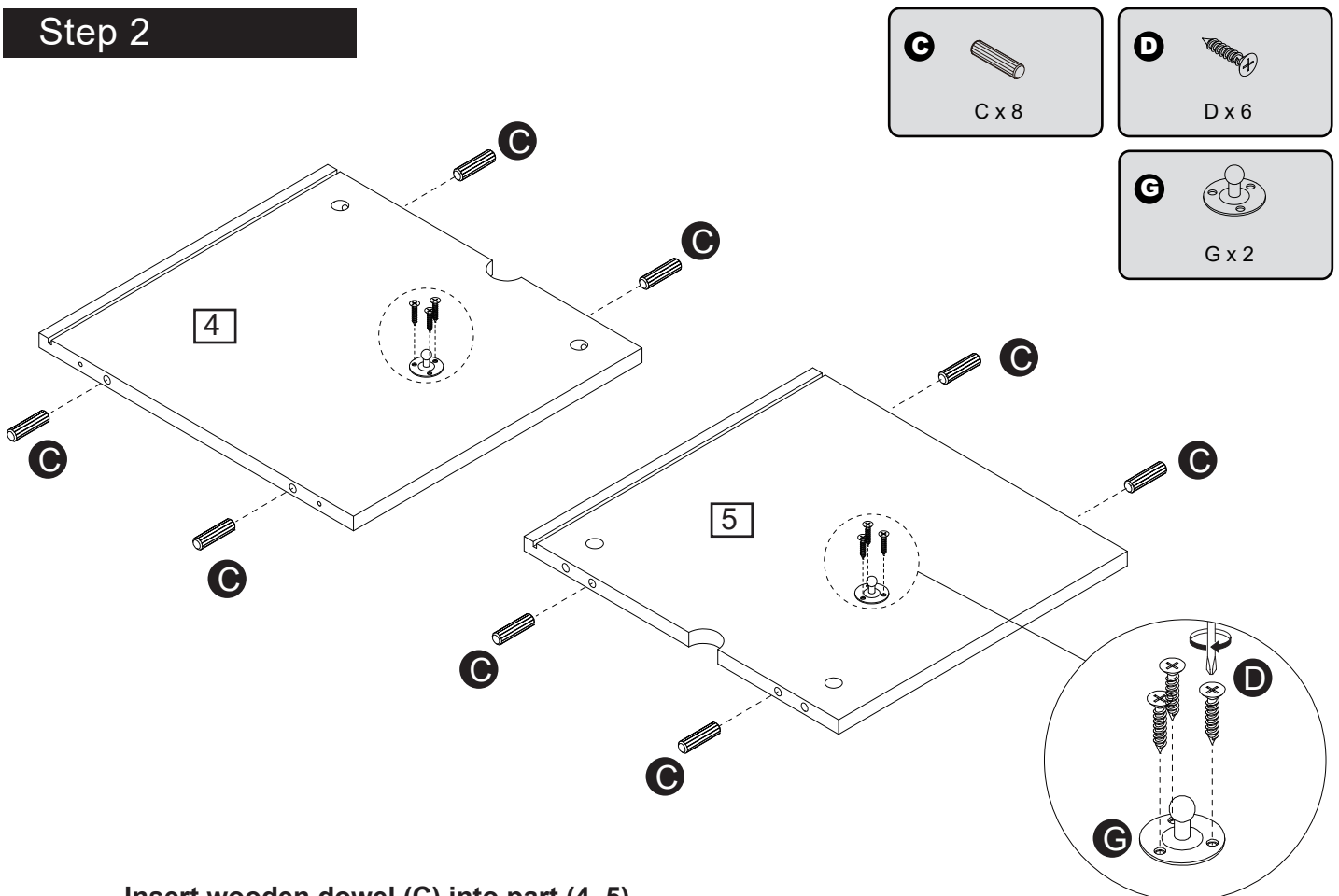

Insert wooden dowel (C) into part (4, 5).
Attach upper ball mounting bracket (G) to part (4, 5) using screw (D).

Assembly Instructions

Step 3

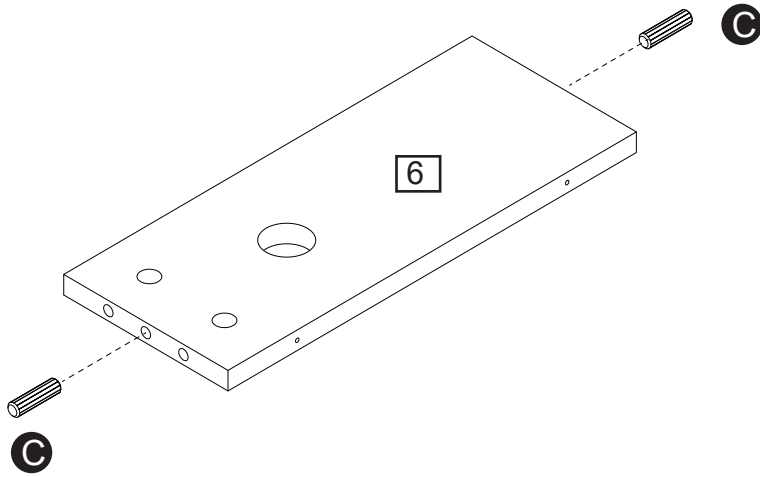

x 2

Insert wooden dowel (C) into part (6).

Step 4

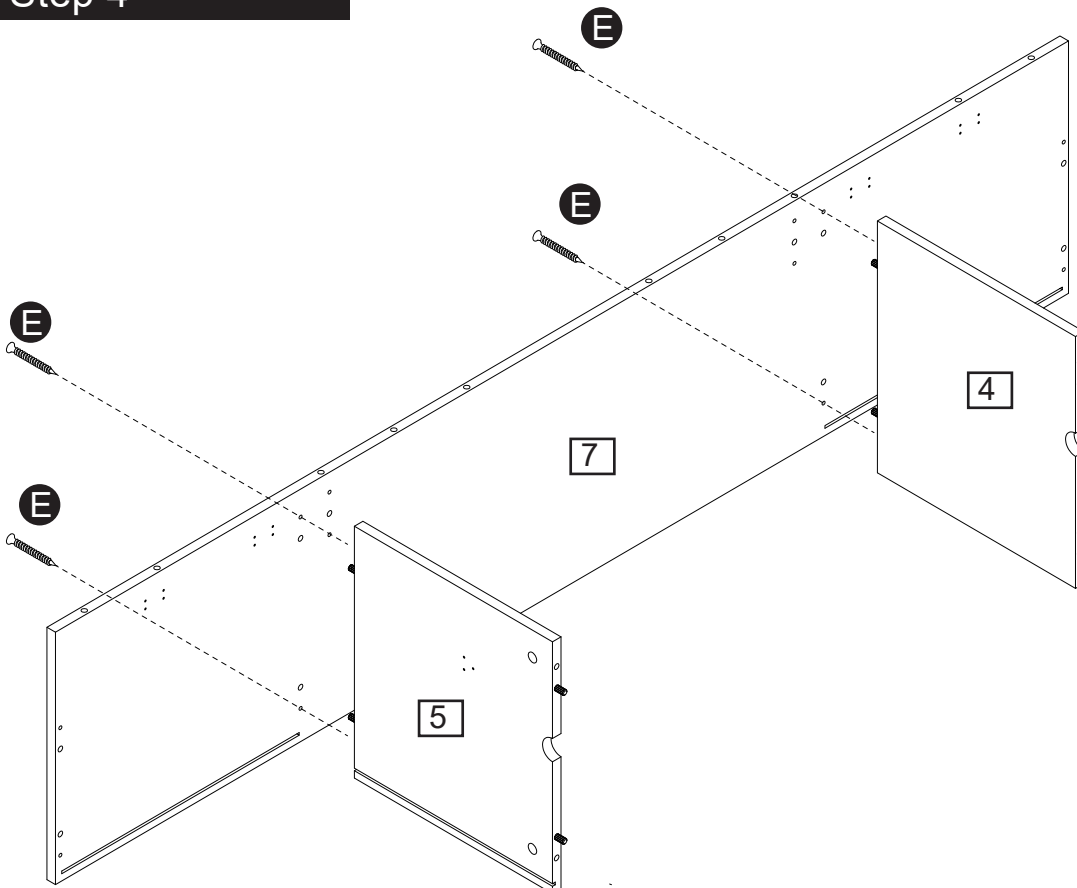

Attach part (4, 5) to part (7) using screw (E) with a screwdriver.

Assembly Instructions

Step 5

 Please note that the cam lock holes on panel (6) need to face each other.

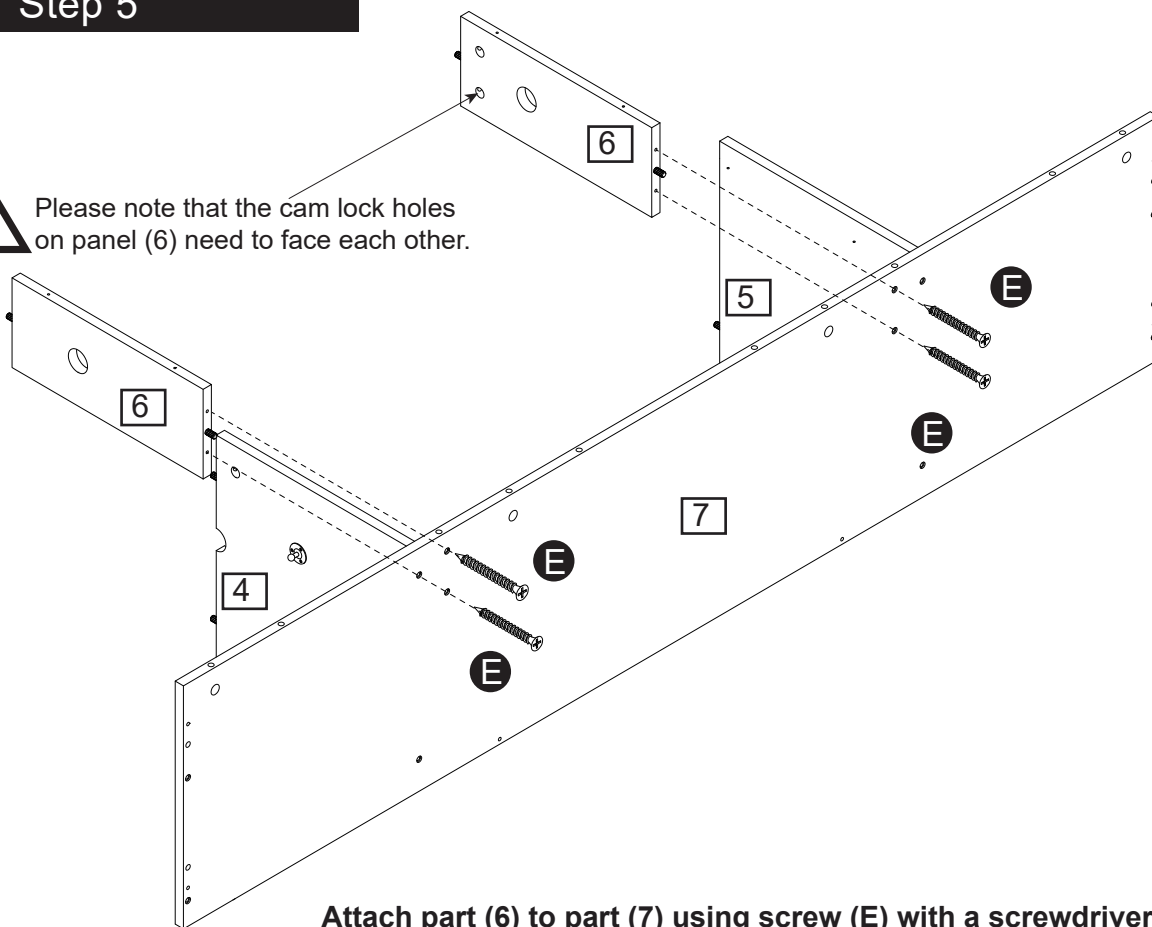

Attach part (6) to part (7) using screw (E) with a screwdriver.

Step 6

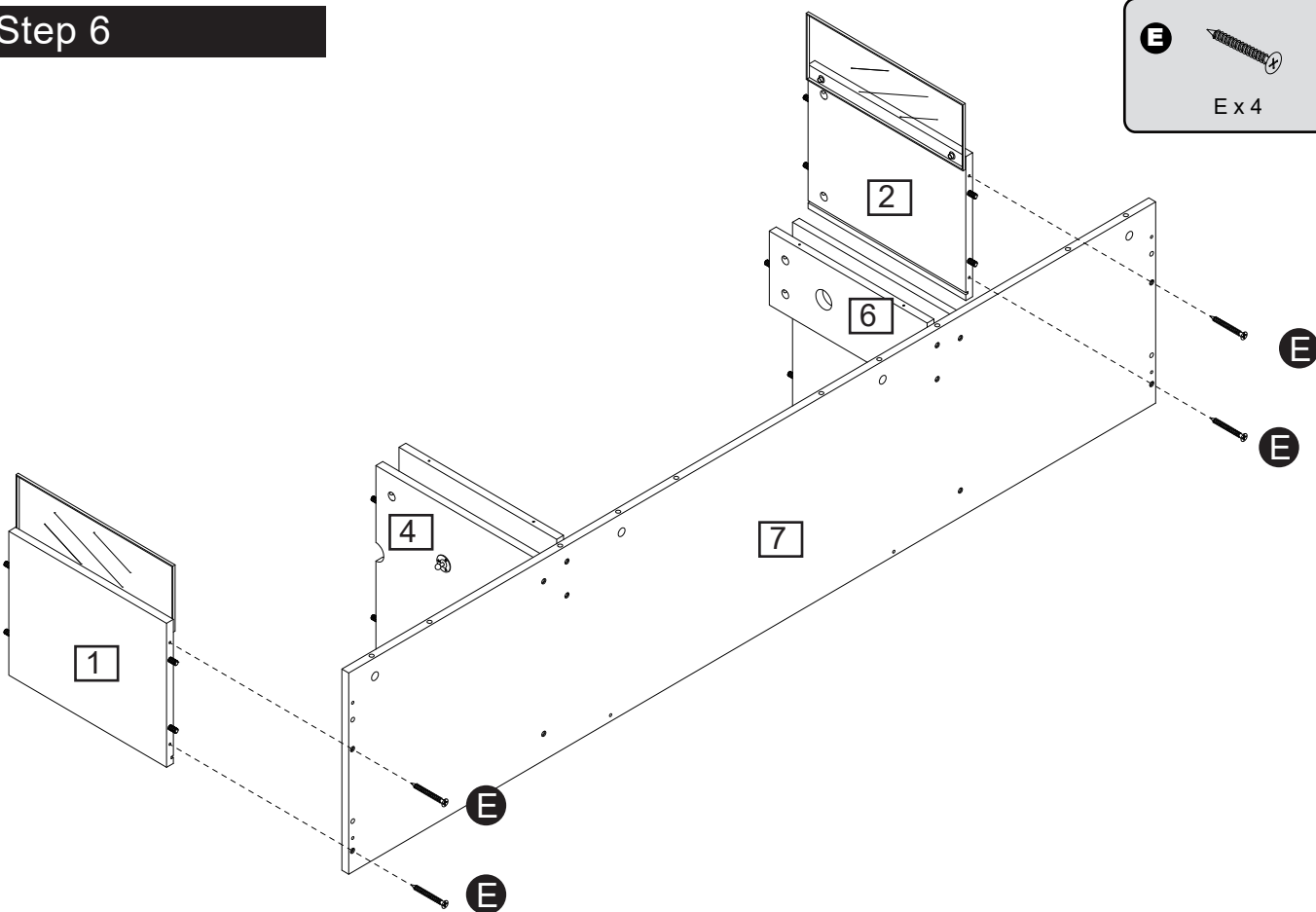

Attach part (1, 2) to part (7) using screw (E) with a screwdriver.

Assembly Instructions

Step 7

CAM-LOCK

Tighten until shoulder is flush with panel. Do not overtighten or undertighten (see example below)

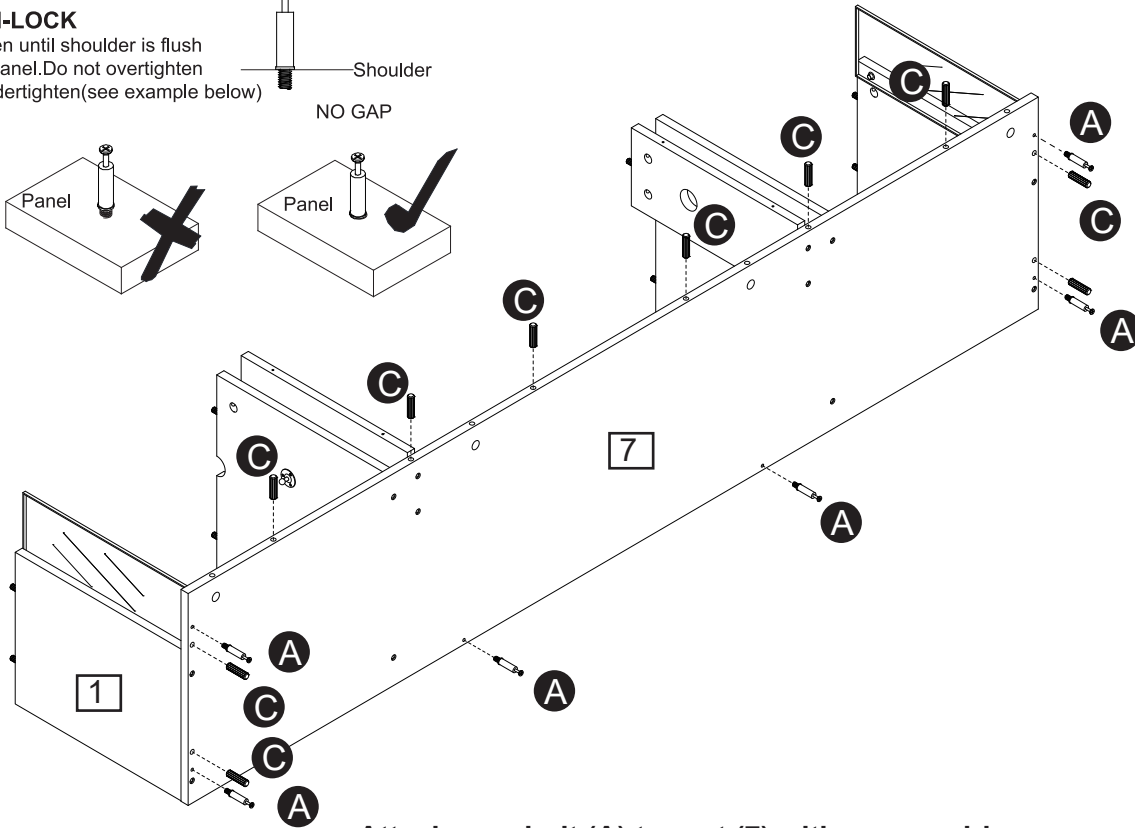
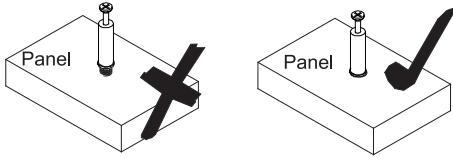
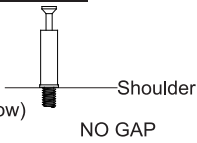

A x 6

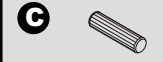

C x 10

Attach cam bolt (A) to part (7) with a screwdriver.
Insert wooden dowel (C) into part (7).

Step 8

CAM-LOCK

Tighten until shoulder is flush with panel. Do not overtighten or undertighten (see example below)

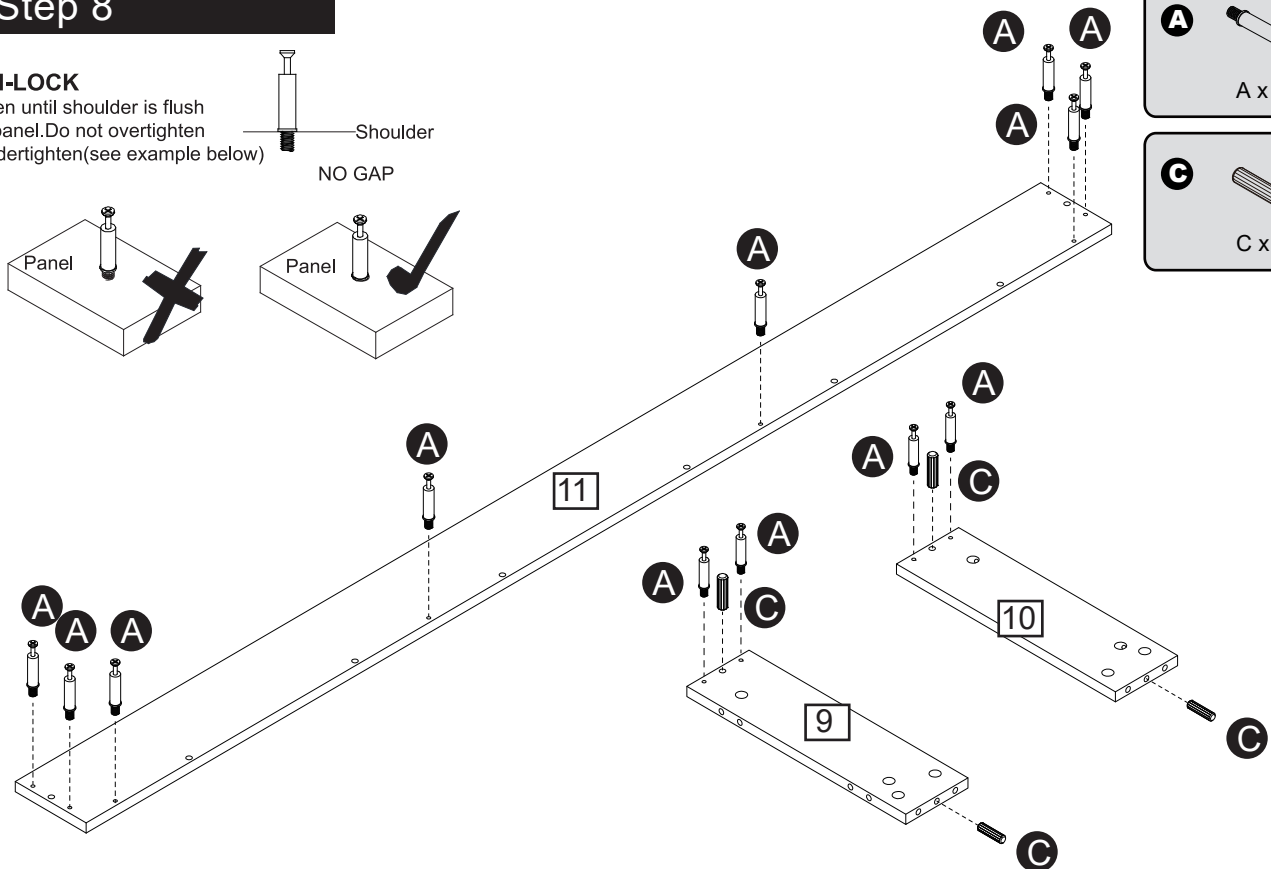
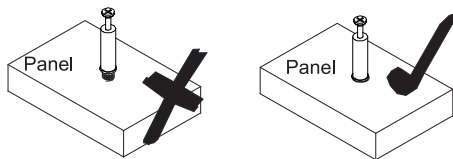
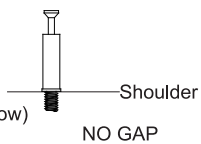

A x 12



C x 4

Attach cam bolt (A) to part (9, 10, 11) with a screwdriver.
Insert wooden dowel (C) into part (9, 10).

Assembly Instructions

Step 9

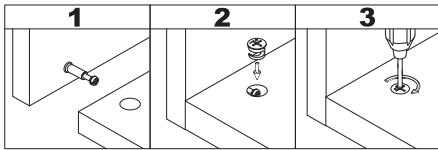

B x 4

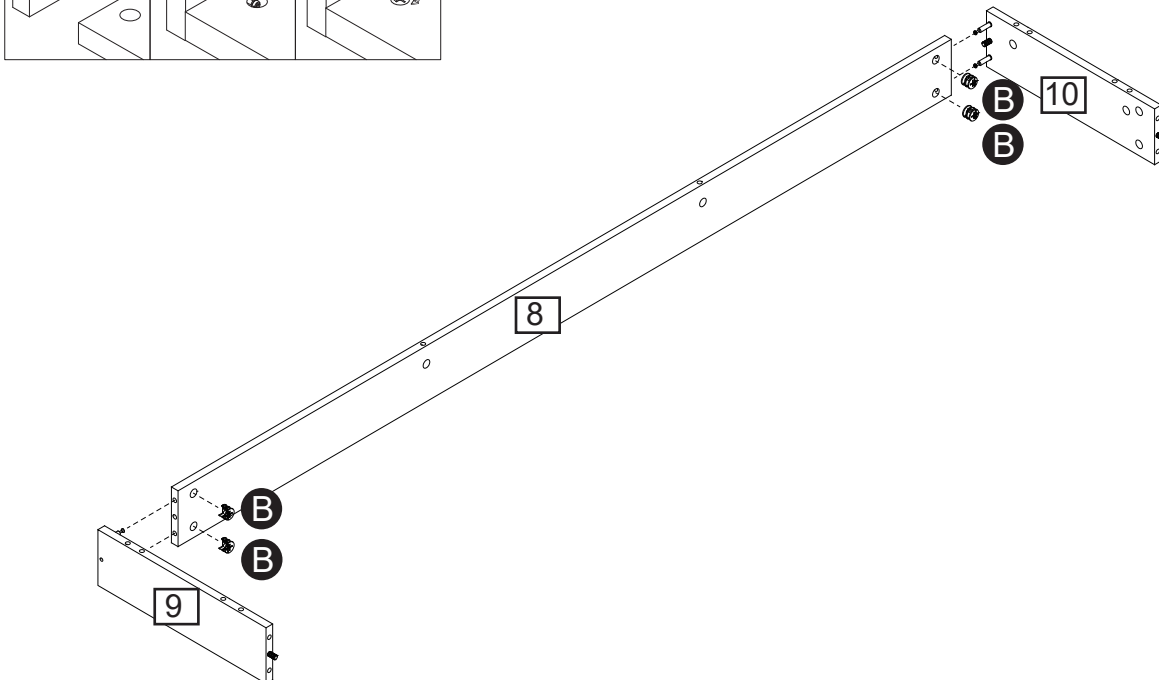

Attach part (9, 10) to part (8), then insert and secure cam lock (B) to part (8) to lock it .

Step 10

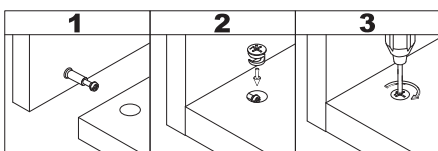

B x 6

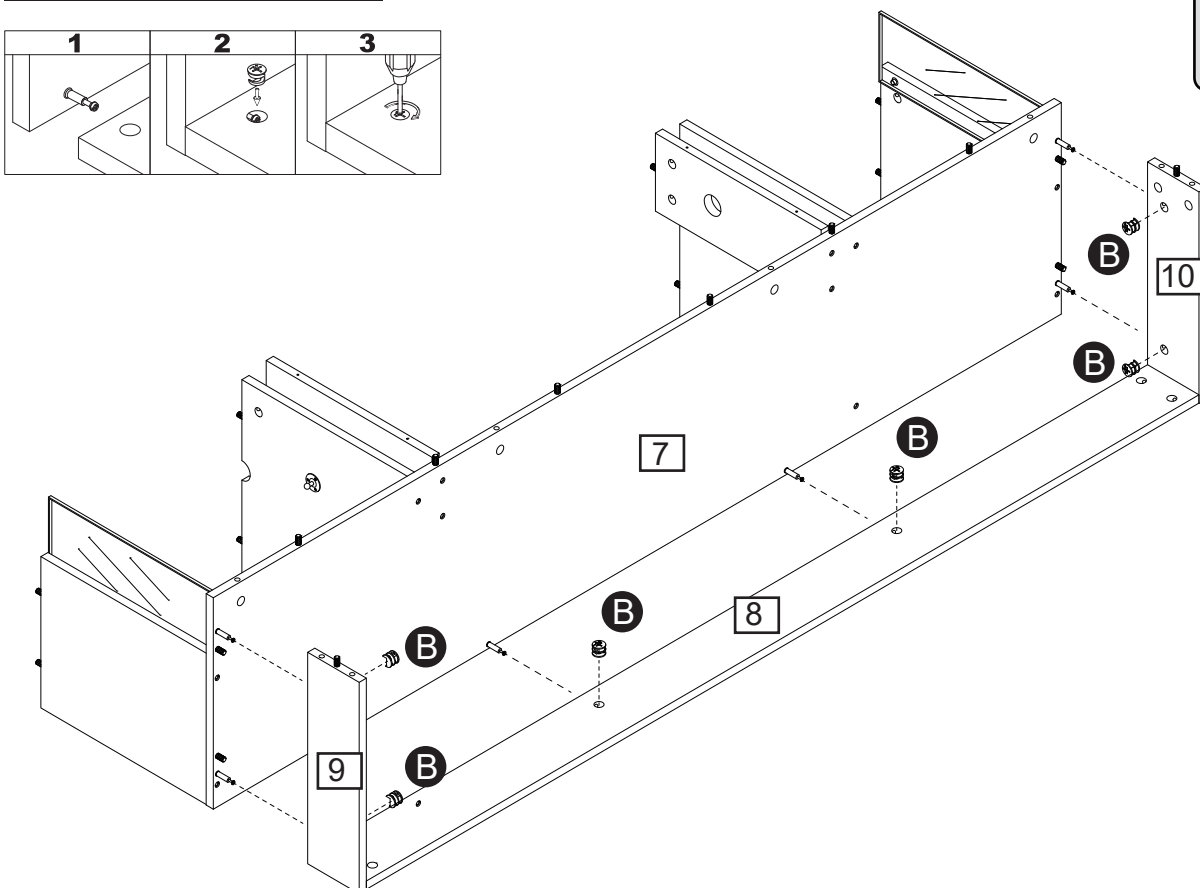

Attach part (8, 9, 10) to part (7), then insert and secure cam lock (B) to part (8, 9, 10) to lock it.

Assembly Instructions

Step 11

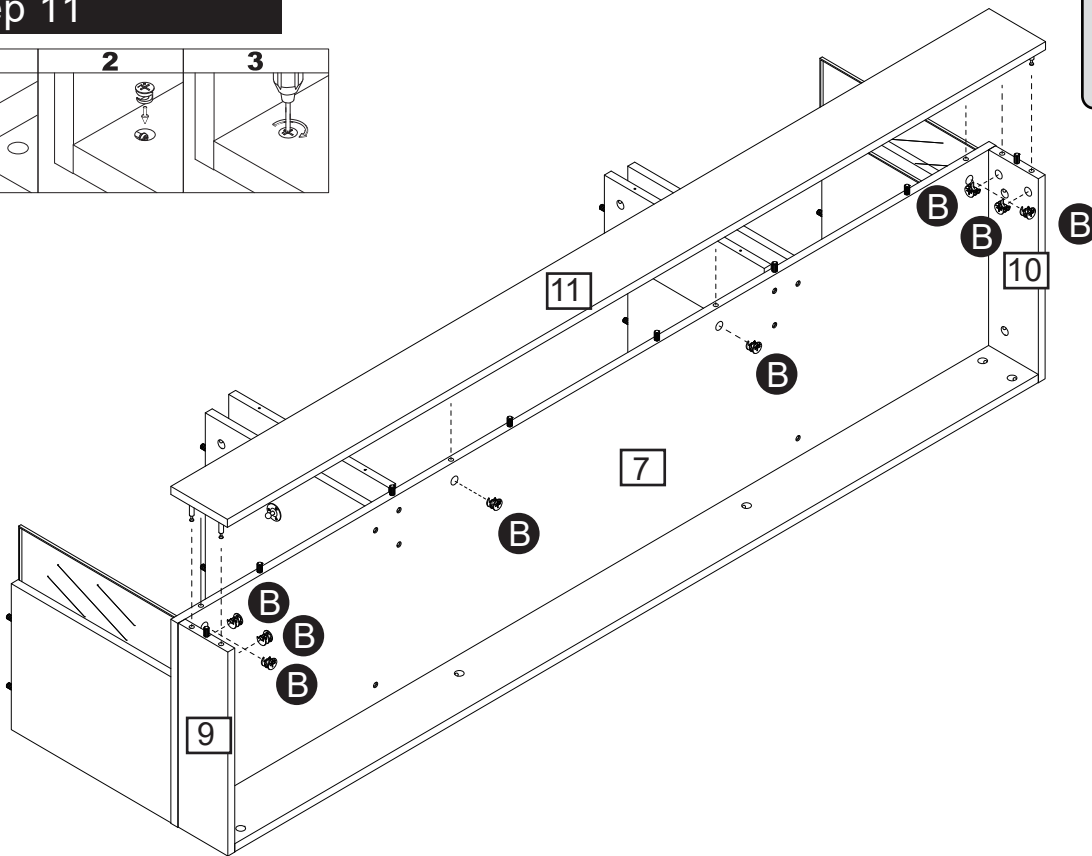
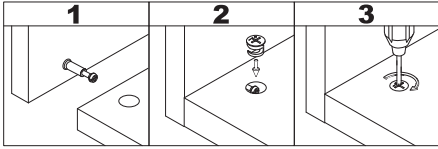

Attach part (11) to part (7, 9, 10), then insert and secure cam lock (B) to part (7, 9, 10) to lock it .

Step 12

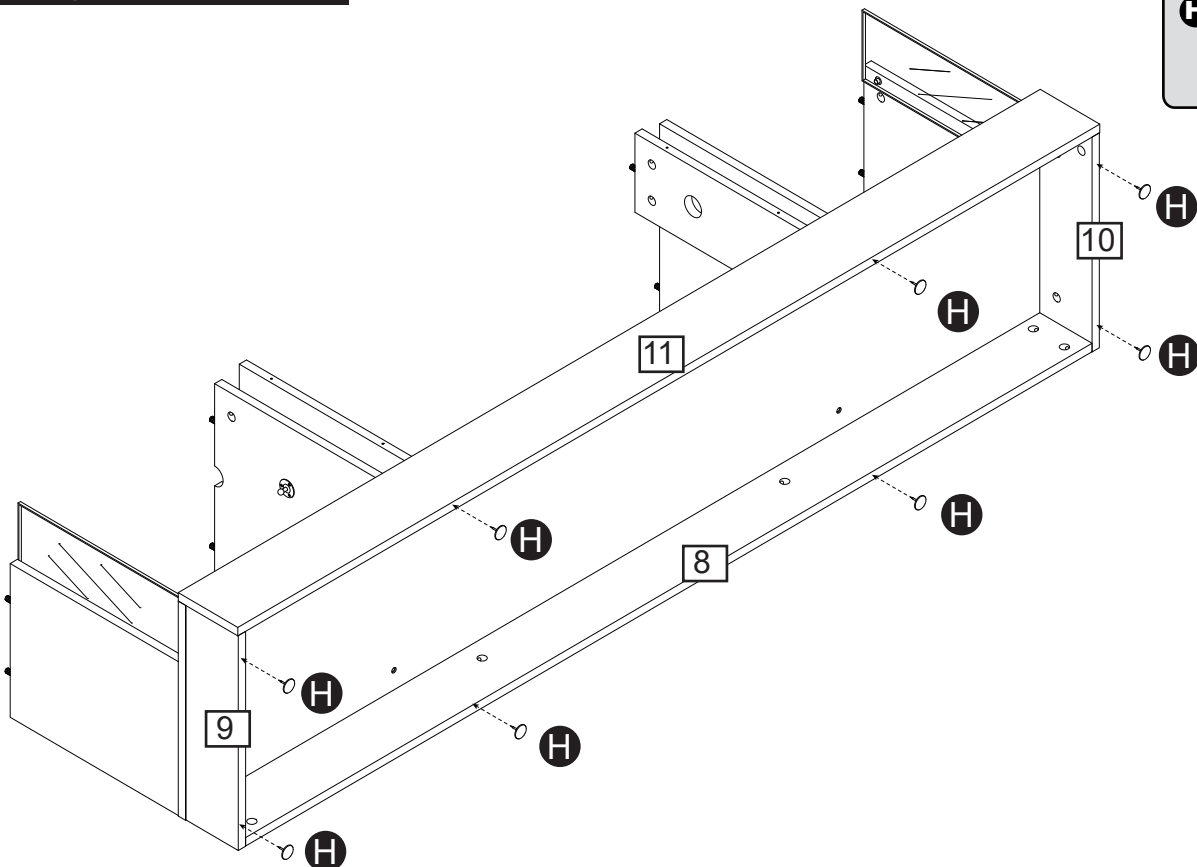

Insert protective foot (H) into part (8, 9, 10, 11).

Assembly Instructions

Step 13

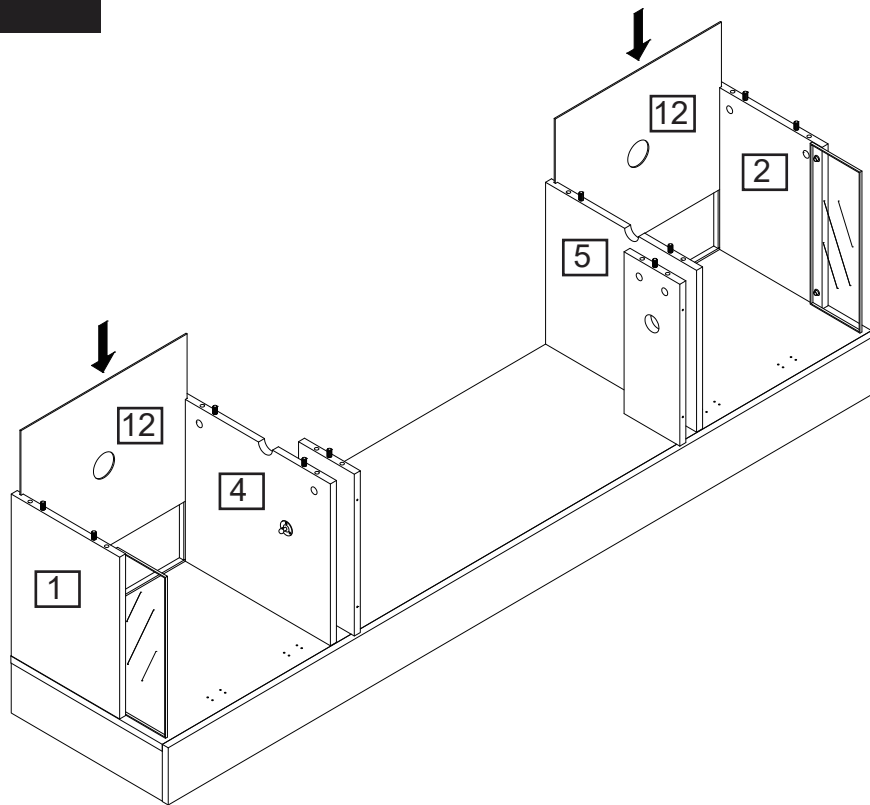

Slide the back panel (12) into grooves as per diagram.

Step 14

CAM-LOCK

Tighten until shoulder is flush with panel. Do not overtighten or undertighten (see example below)

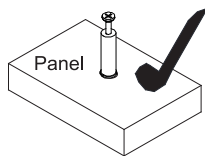
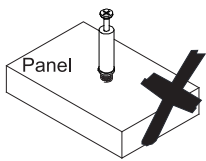
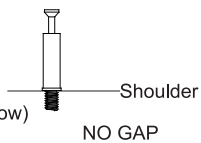

Note: Pay attention to the direction of part (I).

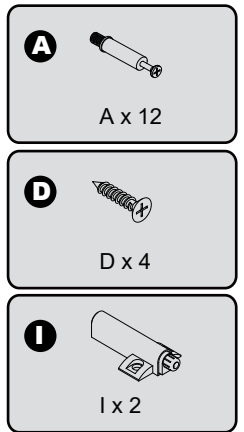
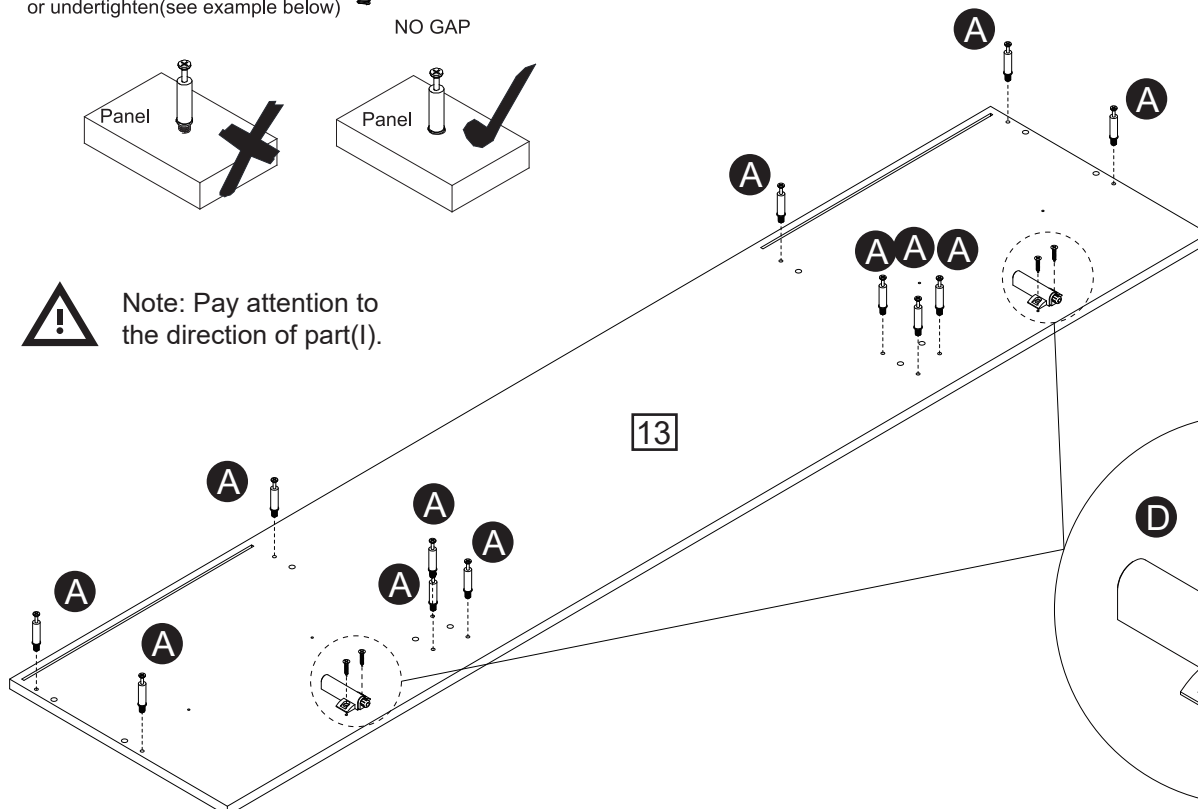

Attach cam bolt (A) to part (13) with a screwdriver, and use screw (D) to secure (I) to part (13) with a screwdriver.

Assembly Instructions

Step 15



Note: LED strip lights are in the BOX of Fireplace, not in the box of TV stand.

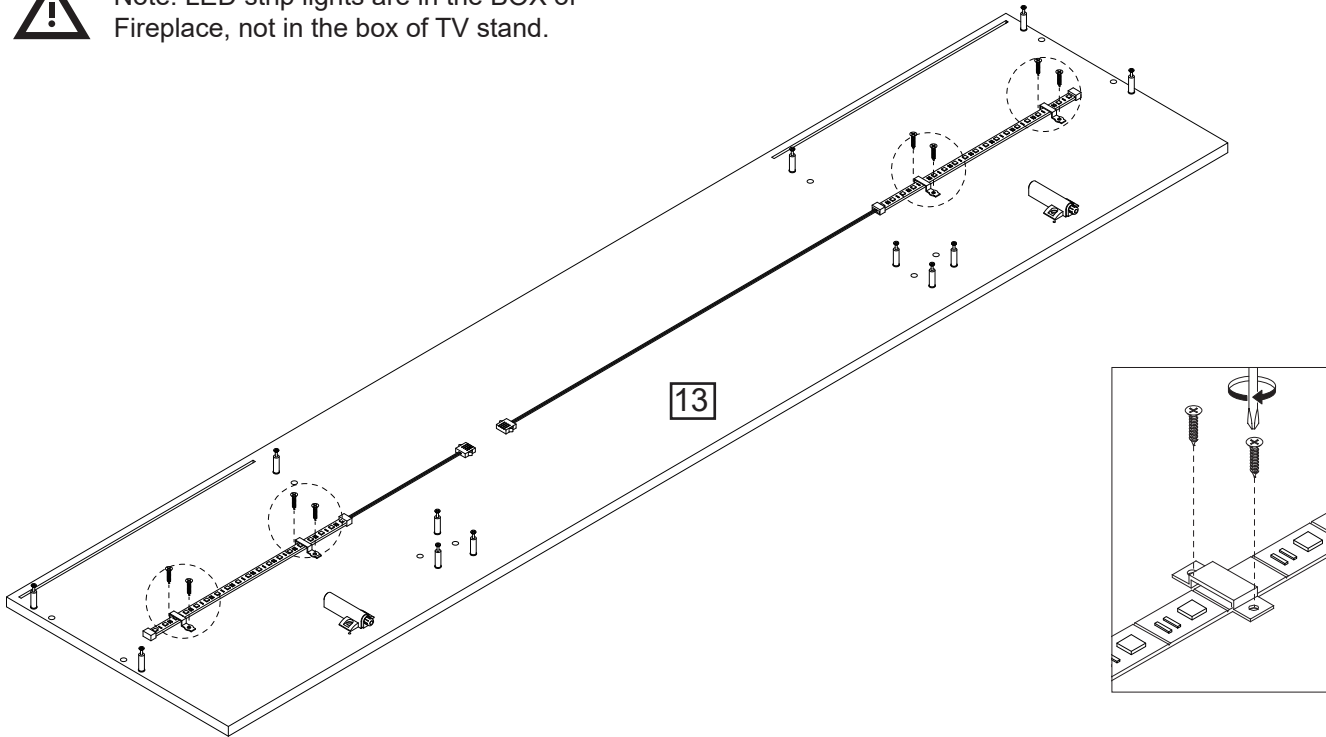

Attach LED strip light to part (13).

Step 16

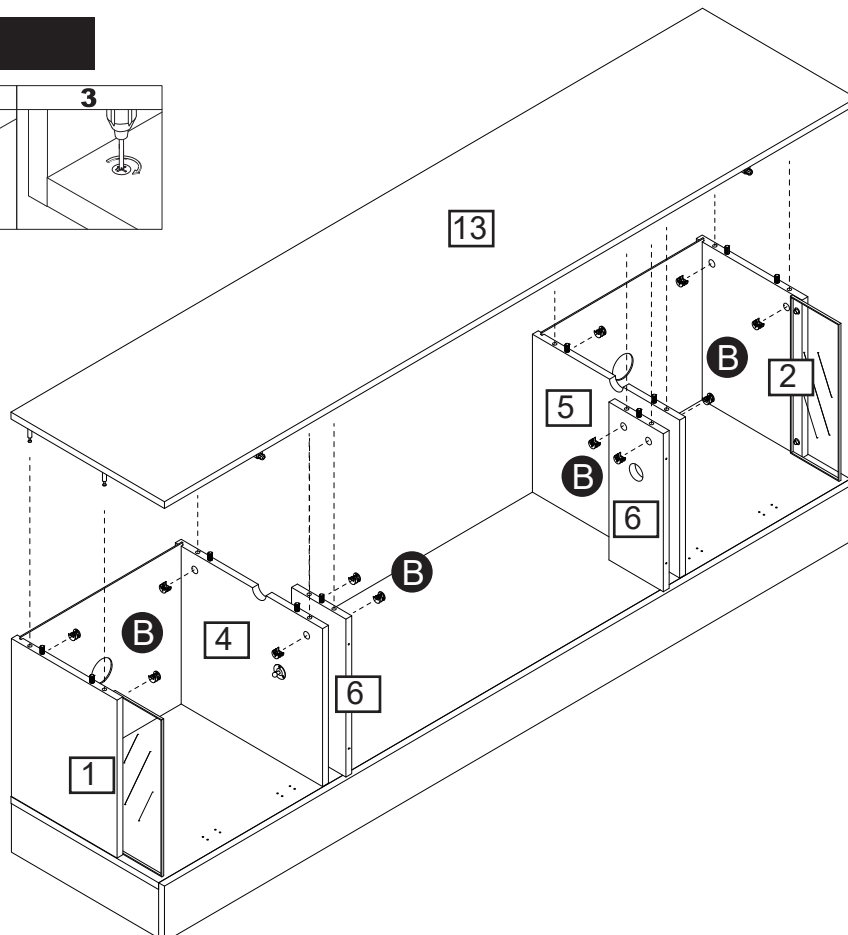
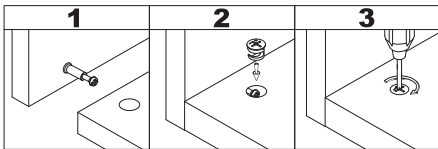

B



B x 12

Attach part (13) to part (1, 2, 4, 5, 6), then insert and secure cam lock (B) to part (1, 2, 4, 5, 6) to lock it .

Assembly Instructions

Step 17

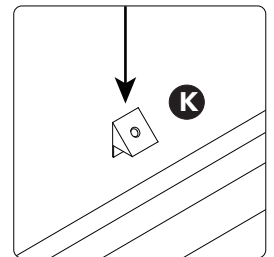
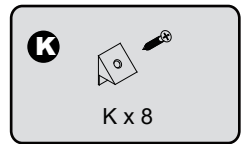
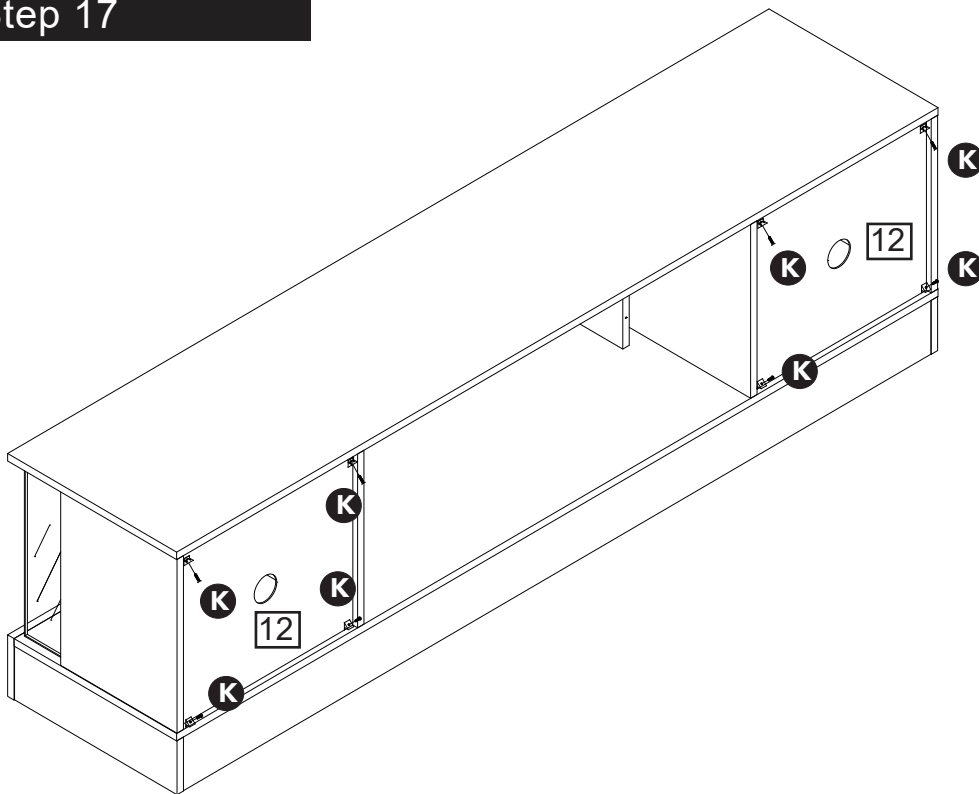

Attach plastic wedge (K) to back panels using screw (K) with a screwdriver.

Step 18

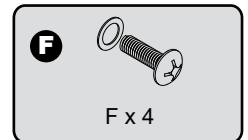
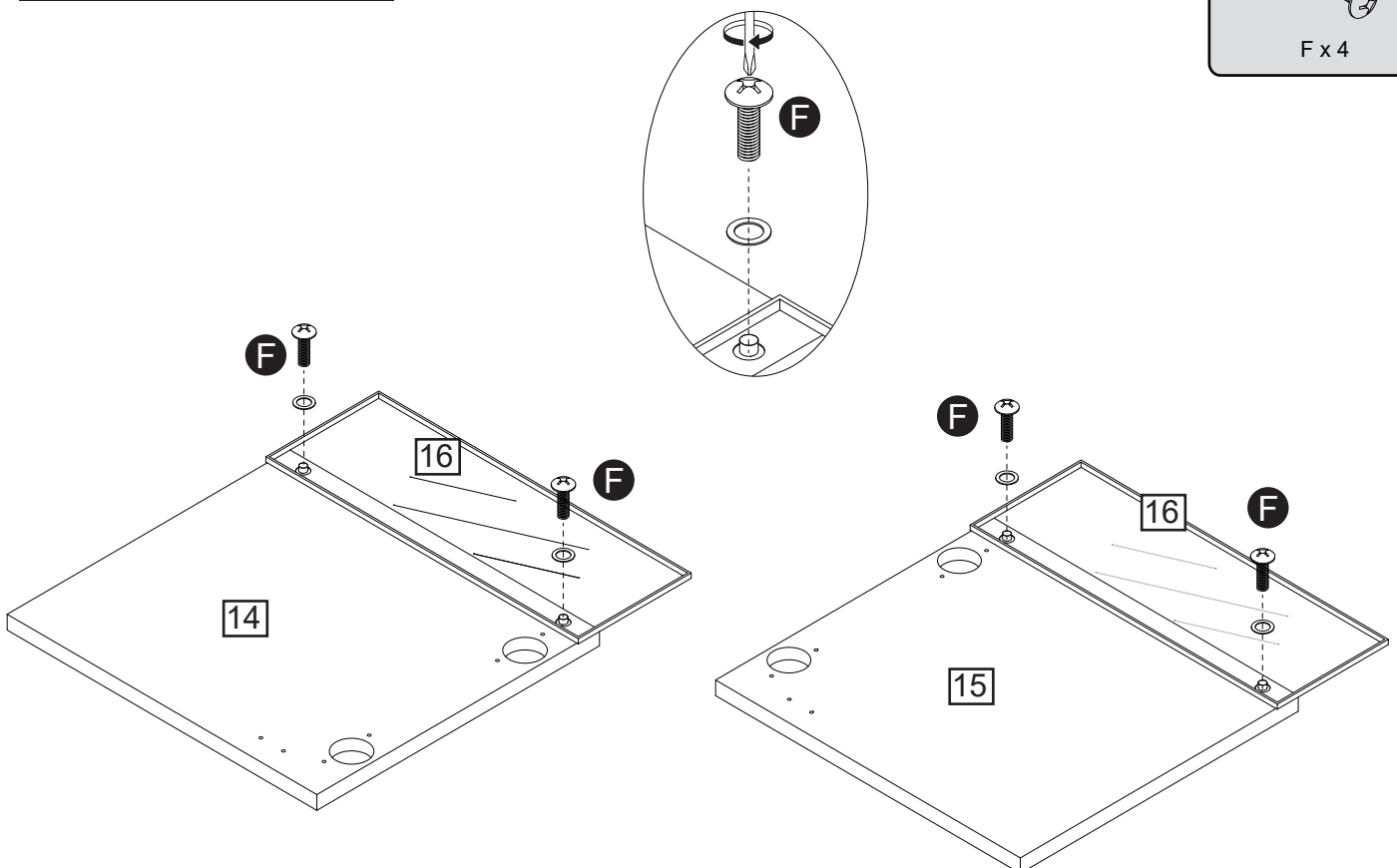

Attach part (16) to part (14, 15) using bolt and washer (F) with a screwdriver.

Assembly Instructions

Step 19

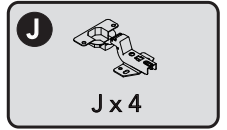
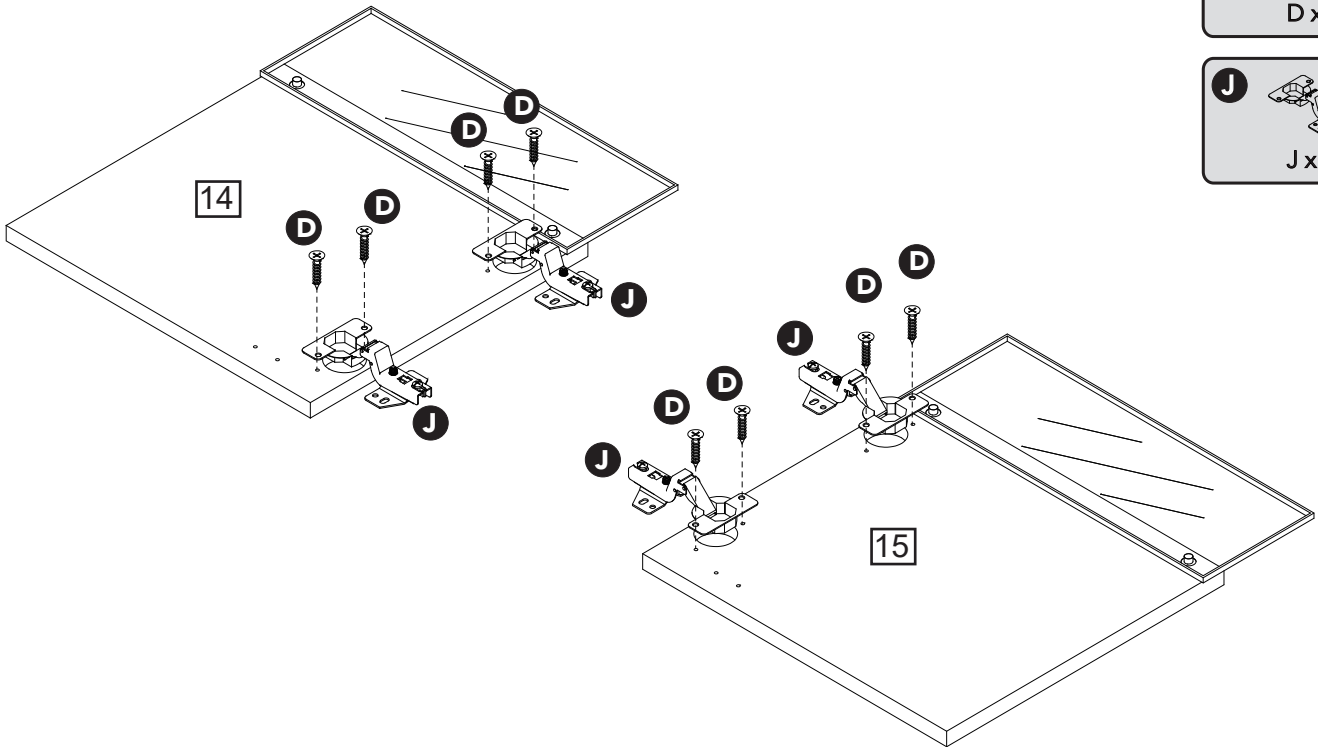

Use screw (D) to secure hinge (J) to part (14, 15).

Step 20

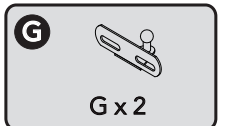
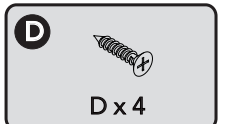
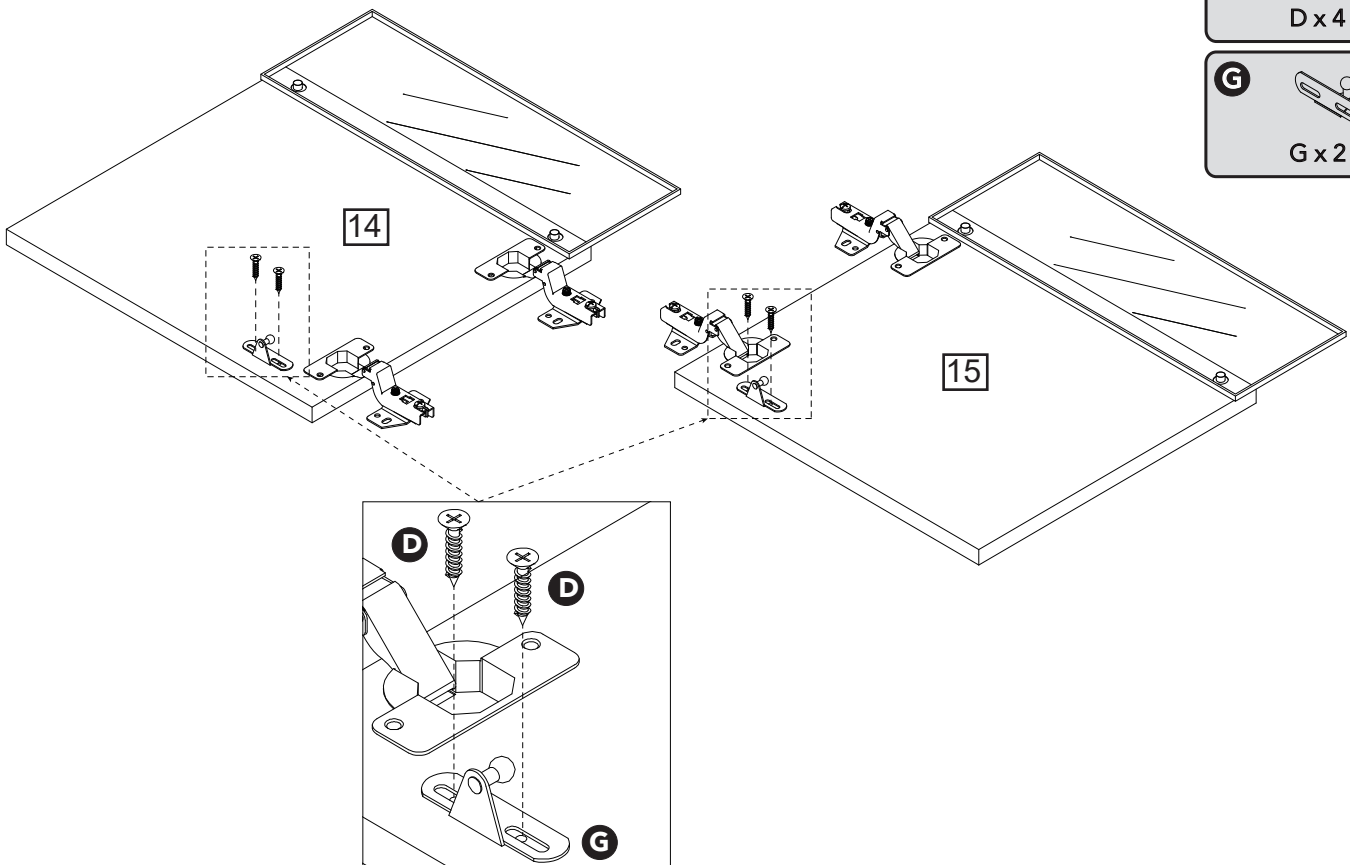

Attach L-shaped lower mounting bracket (G) to part (14, 15) using screw (D) with a screwdriver.

Assembly Instructions

Step 21

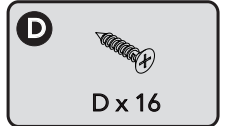
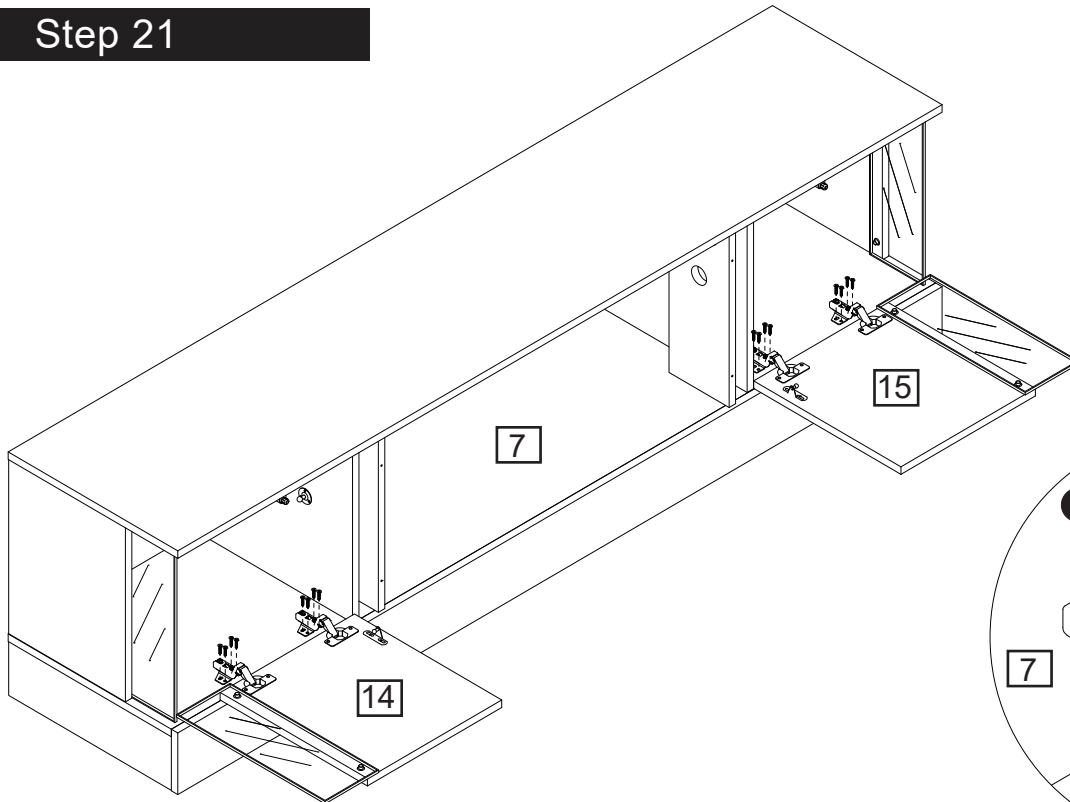

Attach hinge (J) to part (7) using screw (D) with a screwdriver.

Step 22

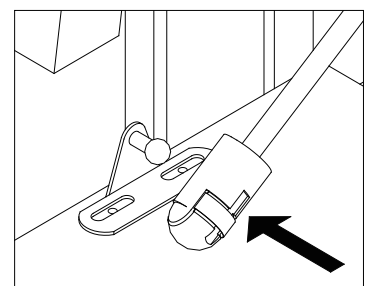
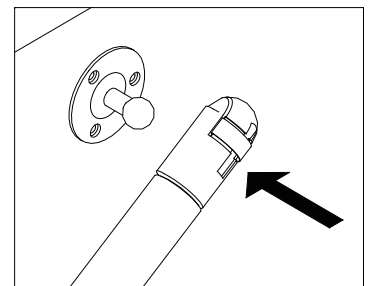
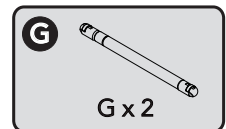
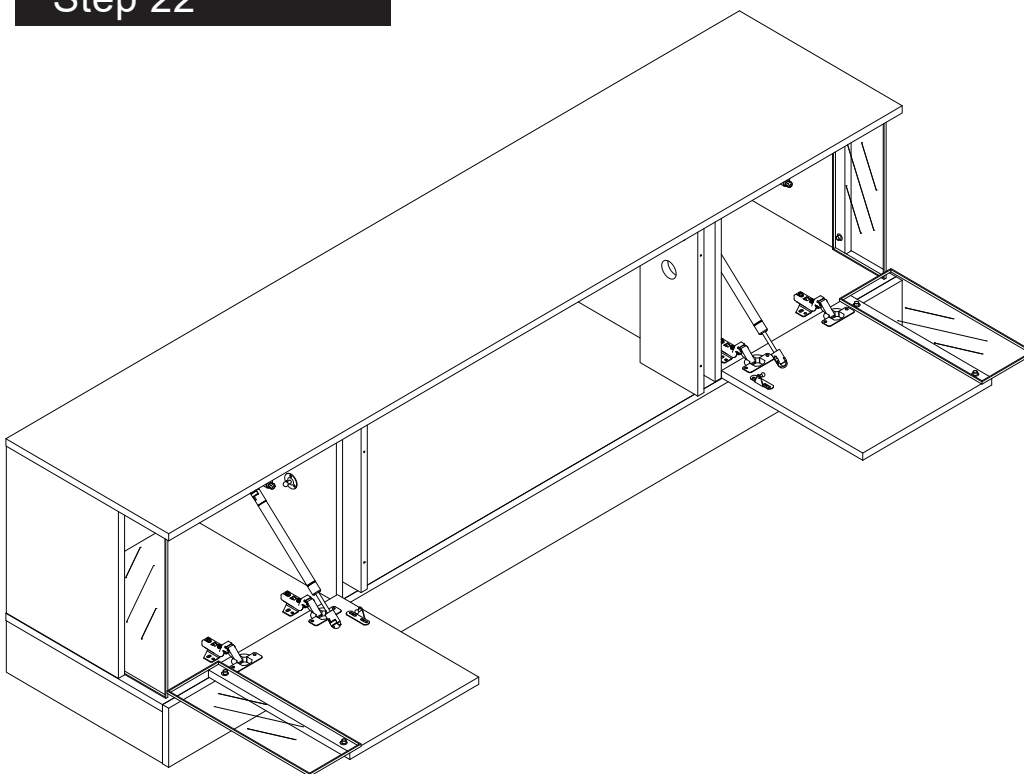

Connect the gas strut to the ball mount.

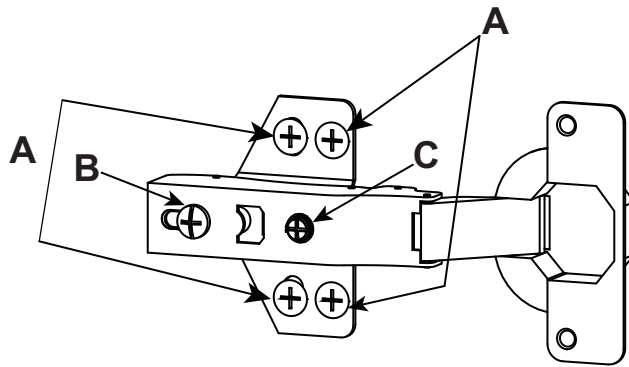

To adjust the side ways.

Loosen the four screws "A" on both hinges. Two of them are usually in slotted holes which allows you to adjust to the left or right by a few mm. Then tighten back up.

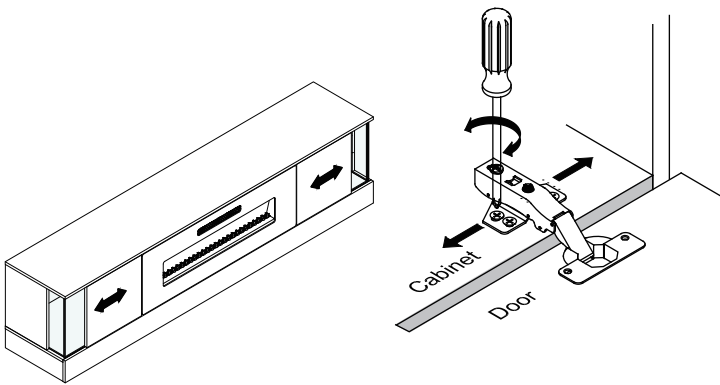

To adjust depth

Loosen screw "B" and adjust door, if the door can not be adjusted, please loosen screw "C", then try again. Tighten screw "B" and "C".

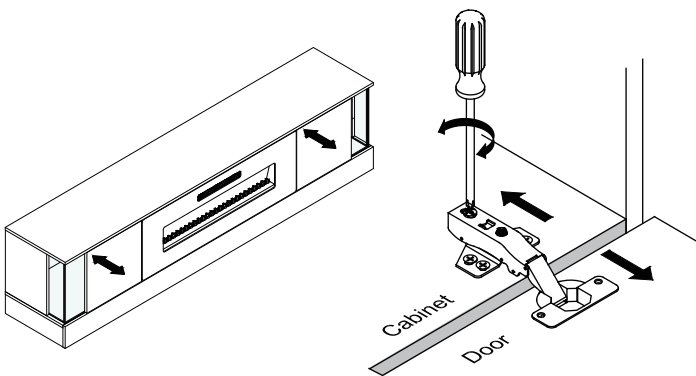

To adjust the vertical height.

Turning the screw "C" on BOTH hinges on each door.

