

# END TABLE

Assembly Instructions - Please keep for future reference

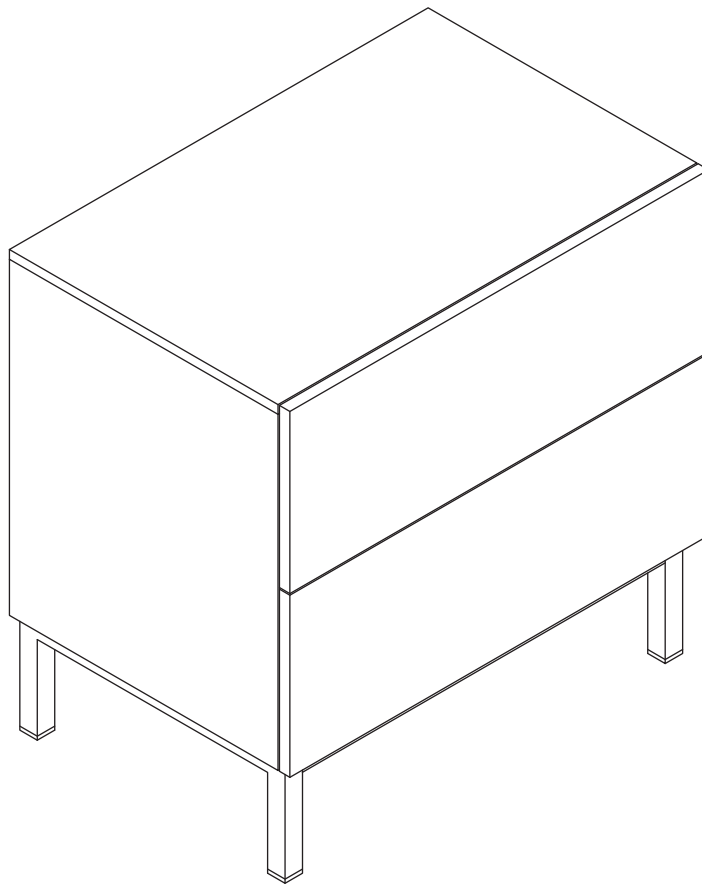

## Dimensions

Width - 23.6 inch  
Depth - 15.7 inch  
Height - 24 inch

Any question please feel free to contact us:  
[support@amer-life.com](mailto:support@amer-life.com) TEL:(901) 347-2181  
We will provide further assistance within 24 hours.

**Important – Please read these instructions fully before starting assembly**

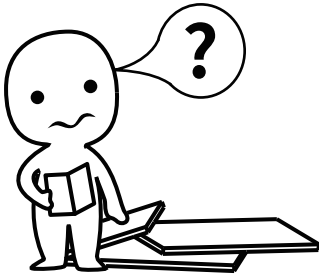

### **IMPORTANT INFORMATION!**

please read the entire manual before starting to assemble and/or using this product. follow the manual thoroughly and keep it for further reference.

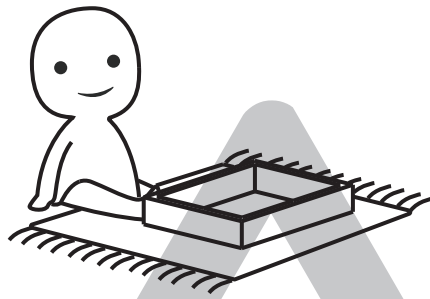

### **AVOID SCRATCHES!**

In order to avoid scratching this furniture should be assembled on a soft layer- could be a rug.

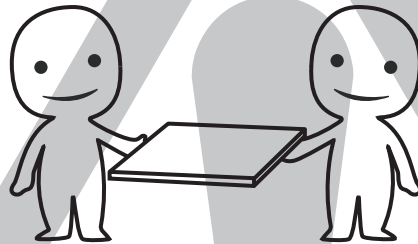

### **IMPROVE EFFICIENCY !**

Try to find a partner to install with you, which can speed up the installation efficiency and shorten the time.

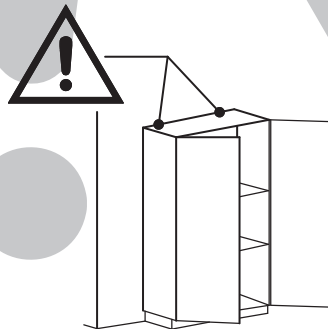
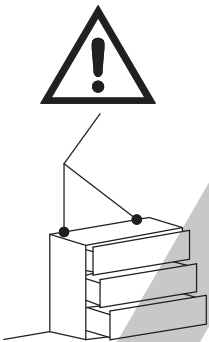

### **ANTI-TOPPLE WARNING !**

Overtured furniture can cause serious or fatal crush injuries. To prevent tipping over, be sure to use the wall attachment, if not included with this product. Please purchase the wall attachment that fit your wall. If unsure, seek professional advice. Please read and follow each step of the instructions carefully.



# Safety and Care Advice

## Important – Please read these instructions fully before starting assembly

- Check you have all the components and tools listed on the following pages.
  - Remove all fittings from the plastic bags and separate them into their groups.
  - Keep children and animals away from the work area, small parts could choke if swallowed.
  - Make sure you have enough space to layout the parts before starting.
  - During assembly do not stand or put weight on the product, this could cause damage.
  - Assemble the item as close to its final position (in the same room) as possible.
  - Assemble on a soft level surface to avoid damaging the unit or your floor.
  - Parts of the assembly will be easier with 2 people.
- 
- To reduce the likelihood of damaging your product please ensure that your power drill is set on a low torque setting.

## Care and maintenance

- Only clean using a damp cloth and mild detergent, do not use bleach or abrasive cleaners.
- From time to time check that there are no loose screws on this unit.
- This product should not be discarded with household waste. Take to your local authority waste disposal centre.

## Handy Hints

- Assemble all parts and bolts loosely during assembly, only once the product is complete should you fully tighten the bolts
- Regularly check and ensure that all bolts and fittings are tightened properly.

## **WARNING** In order to help prevent overturning – please follow these instructions

To help prevent product toppling over please follow the below steps:-

Use the anti tip strap or wall fixing method provided (if applicable)  
Do not allow children to climb or hang on the furniture  
Do not open more than one drawer at a time  
Do not place heavy items in the top drawers  
Do not place heavy items on top of the furniture, unless the furniture has been designed for this purpose

Please note that only the anti tip strap is provided.  
You will need to provide wall plugs and screws applicable for your wall type

# Componets - Panels

Please check you have all the panels listed below

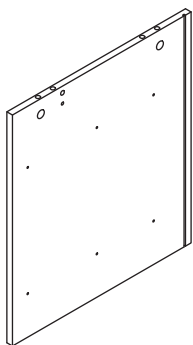

1 (430\*384\*12mm x1)

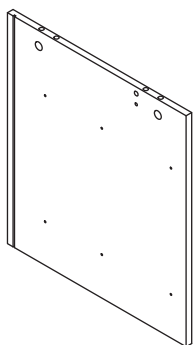

2 (430\*384\*12mm x1)

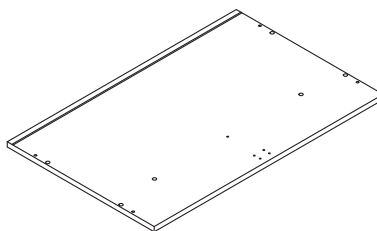

3 (600\*385\*12mm x1)

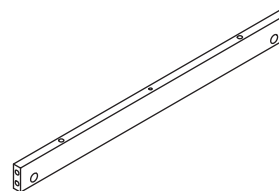

4 (574\*45\*15mm x1)

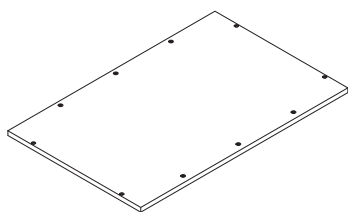

5 (600\*385\*12mm x1)

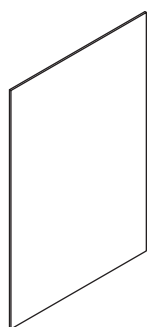

6 (444\*291\*3mm x2)



7 (435mm x1)

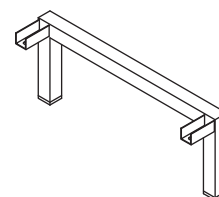

8 (380\*150\*25mm x2)

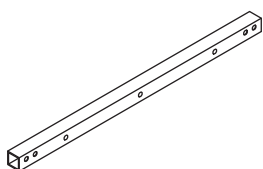

9 (520\*25\*25mm x2)

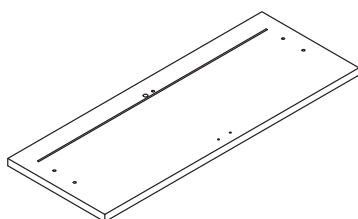

10 (600\*229\*15mm x1)

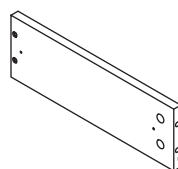

11 (350\*115\*12mm x2)

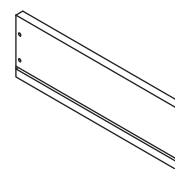

12 (350\*115\*12mm x2)

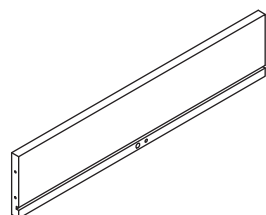

13 (530\*115\*12mm x2)

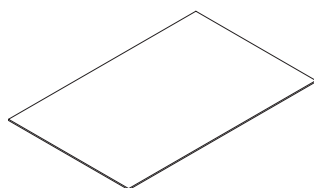

14 (345\*538\*3mm x2)

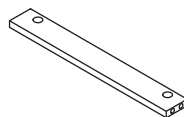

15 (337\*45\*12mm x2)

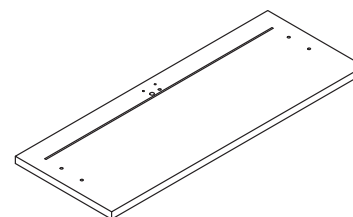









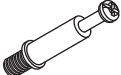



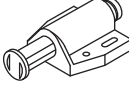

16 (600\*229\*15mm x1)

# Componets - Fittings

Please check you have all the fittings listed below

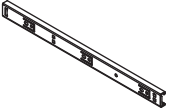
Note: The quantities below are the correct amount to complete the assembly. In some cases more fittings may be supplied are required.

<b>A</b>  6*35mm x 18	<b>B</b>  15*9.5mm x 18	<b>C</b>  6*30mm x 16
<b>D</b>  3.5*12mm x 20	<b>E</b>  3*14mm x 12	<b>F</b>  4*35mm x 13
<b>G</b>  x 2	<b>H</b>  x 2	<b>I</b>  6*16mm x 8
<b>J</b>  6*35mm x 6	<b>K</b>  x 1	<b>L</b>  x 8
<b>M</b>  x 4	<b>N</b>  x 4	<b>O</b>  3*18mm x 8

## Tools required



Phillips screwdriver  
(medium & large)

## Ruler - Use this ruler to help correctly identify the screws

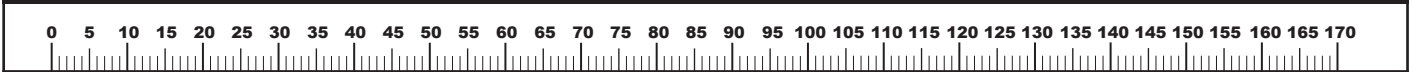

The screws length is measured from the head to the point (30mm screw shown).

# Using Camlocks

## Step 1

Connect the male camlock as directed in the assembly instructions using a screwdriver.

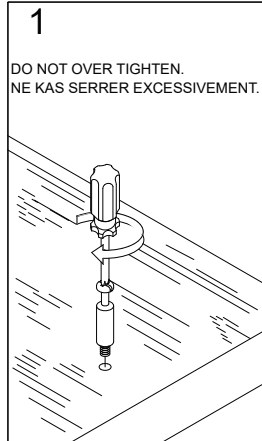

## Step 2

Push the male camlock into the entry hole.

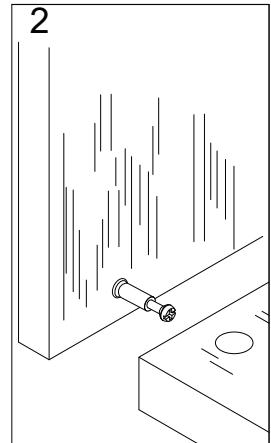

## Step 3

Insert the female camlock as shown in the instructions.

Note: ensure that the arrow on the top of the camlock points towards the entry hole for the male camlock.

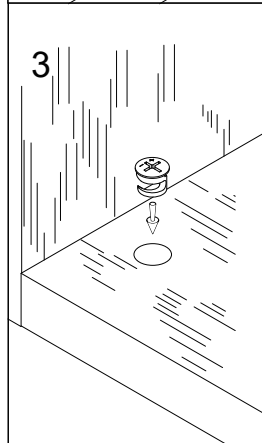

## Step 4

Turn the female camlock clockwise with a screwdriver.

You should feel a click when the camlock is locked in place.

The joint is now secure.

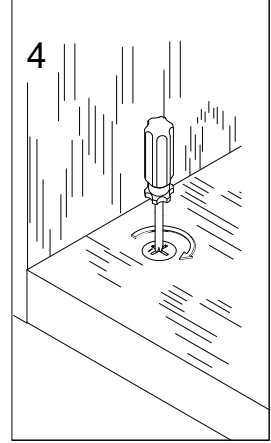

# Assembly Instructions

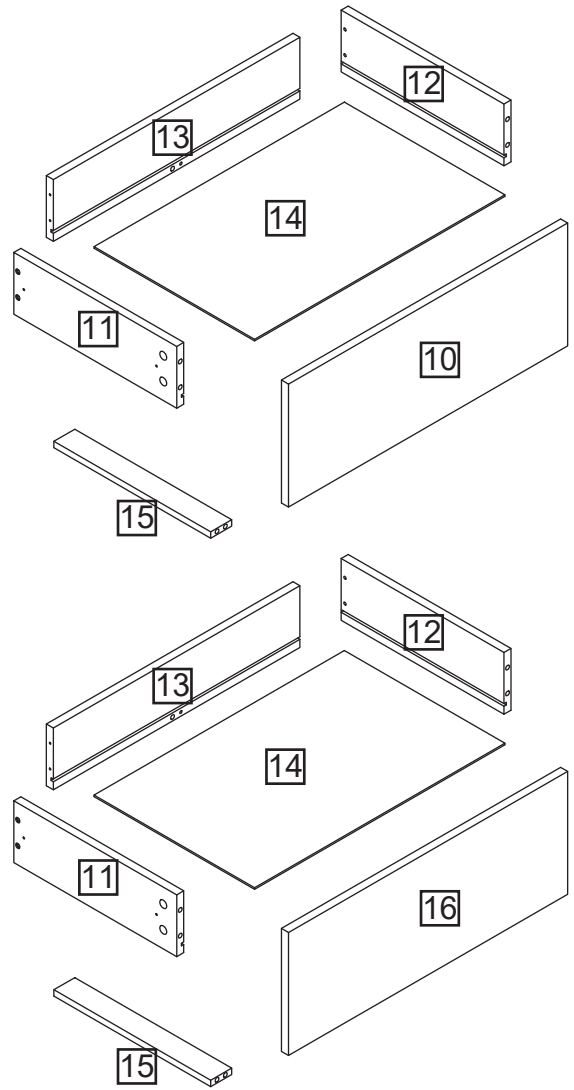
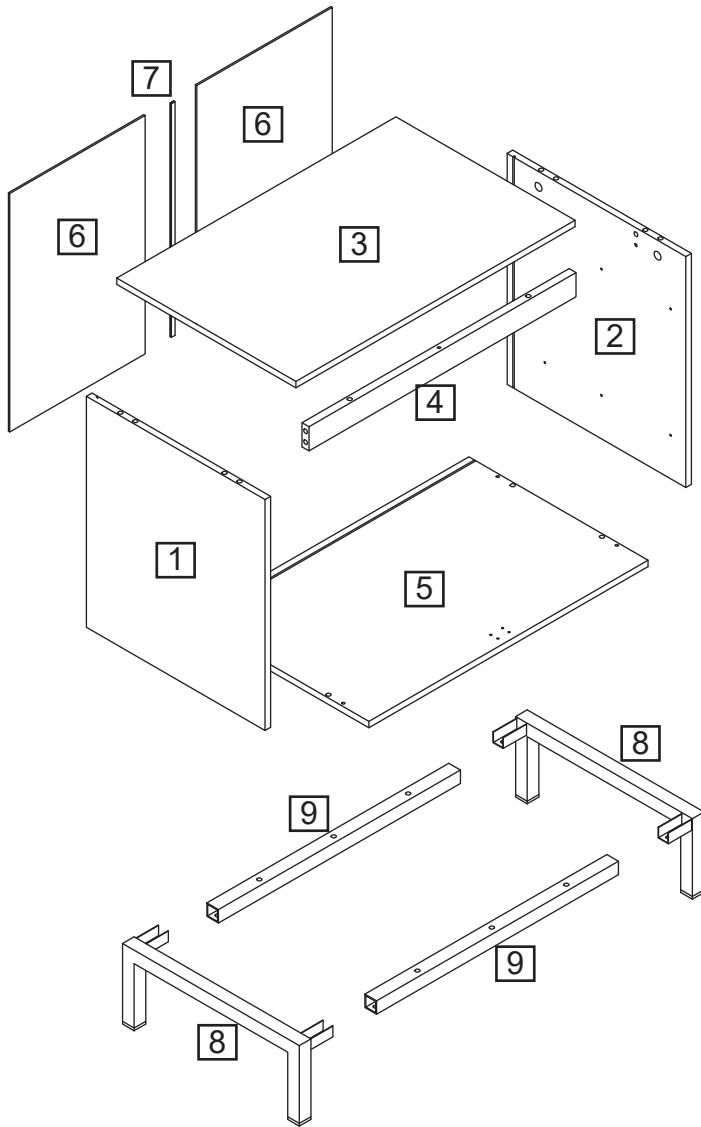

**Slides Must Be Separated Before Assembly.  
After Separated, Set Aside Until Needed for Assembly.**

**Pay attention when connecting !  
The sliding module must be at the front end.**

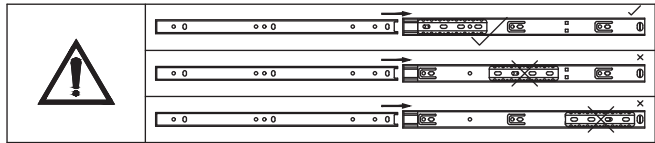

**STEP 1 : Extend Slide**  
Extender la diapositiva

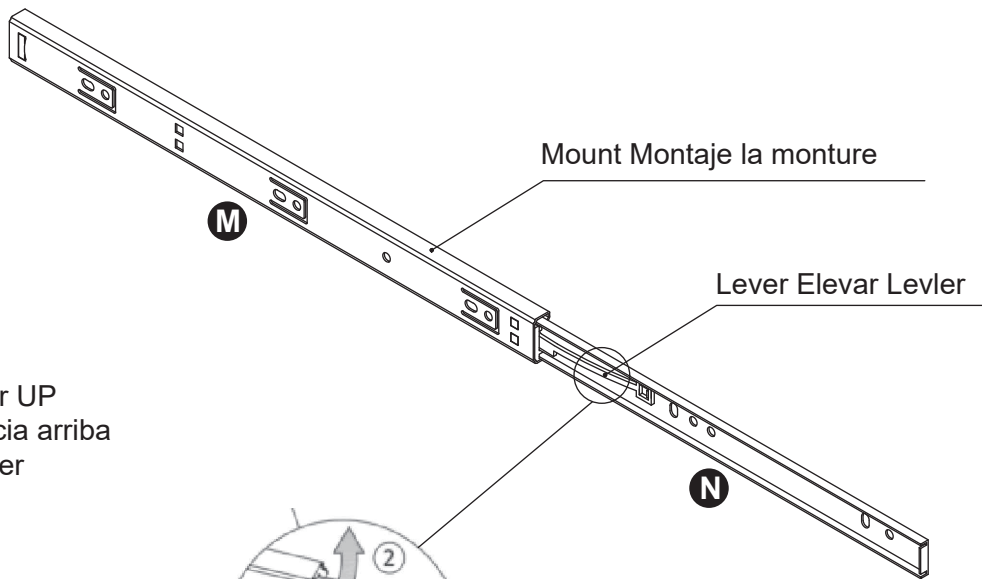

**STEP 2: Push Lever UP**  
Empujar hacia arriba  
Levier le levier

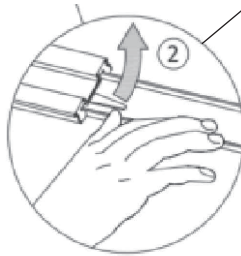

**Push lever for the left of drawer ,  
press the lever for the right of drawer.**

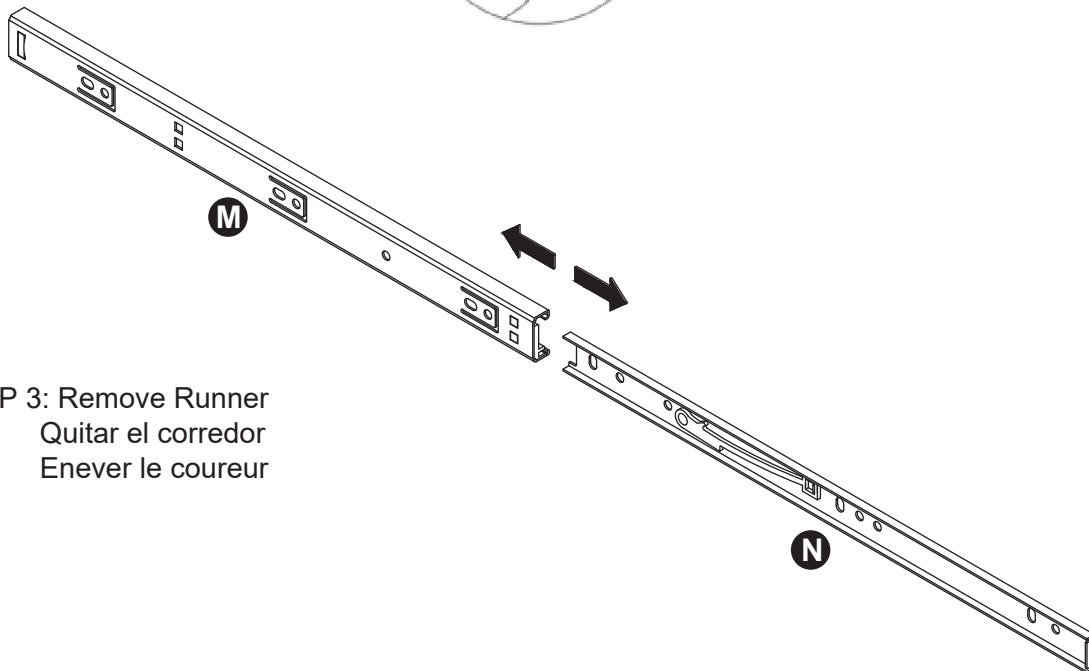

**STEP 3: Remove Runner**  
Quitar el corredor  
Enever le coureur



# Assembly Instructions

## Step 1

### CAM-LOCK

Tighten until shoulder is flush with panel. Do not overtighten or undertighten (see example below)

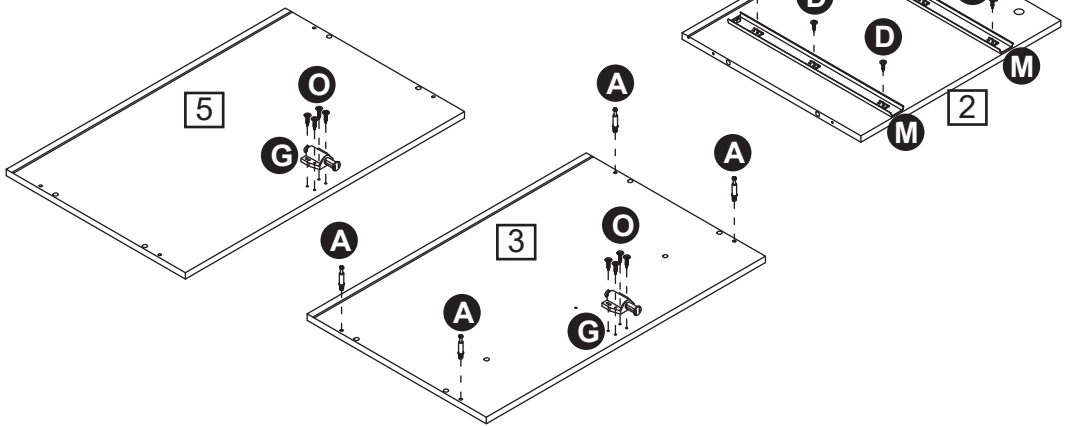
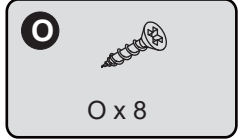
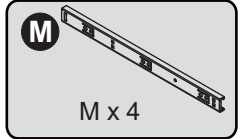
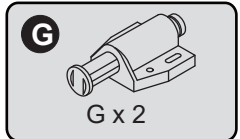
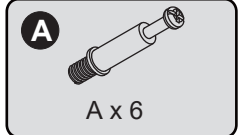
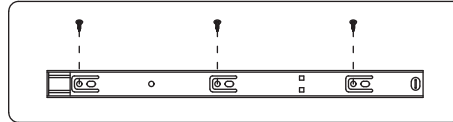
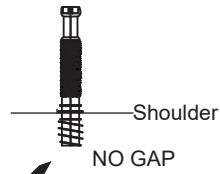
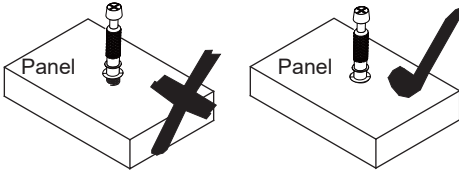

## Step 2

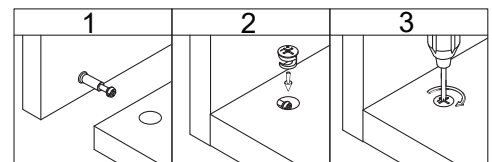
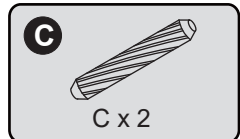
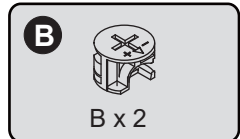
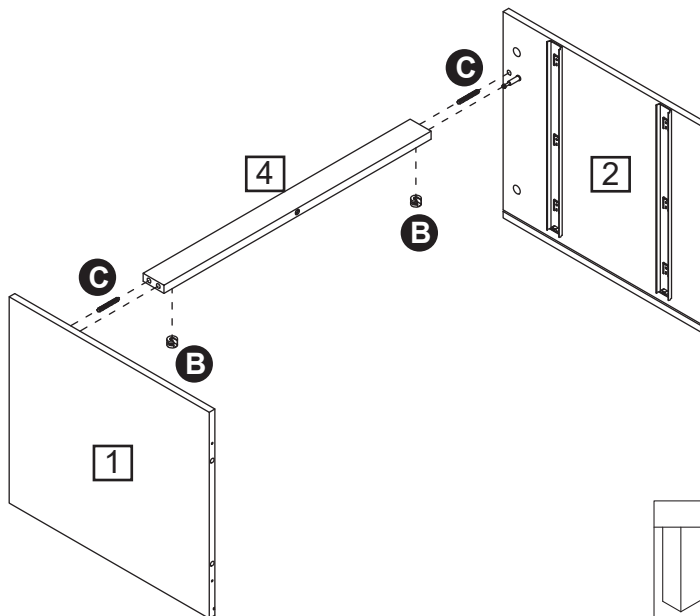

# Assembly Instructions

## Step 3

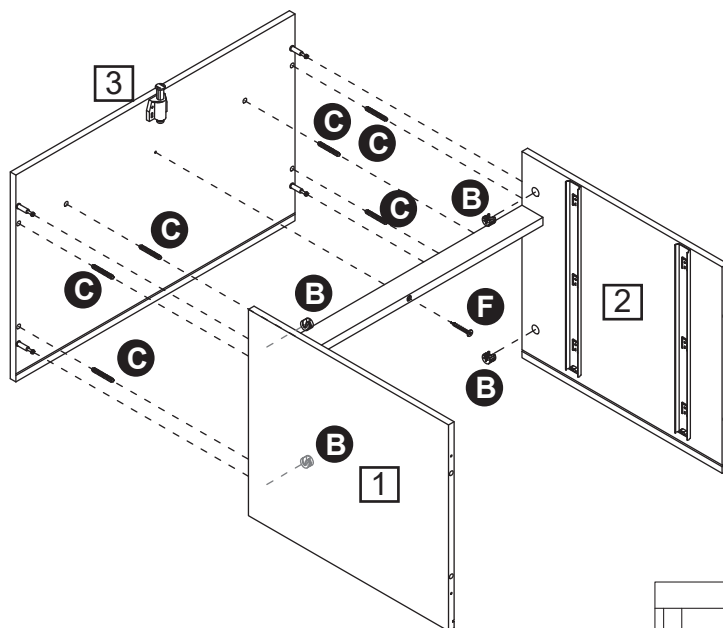

B x 4



C x 6



F x 1

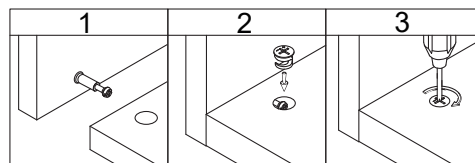

## Step 4

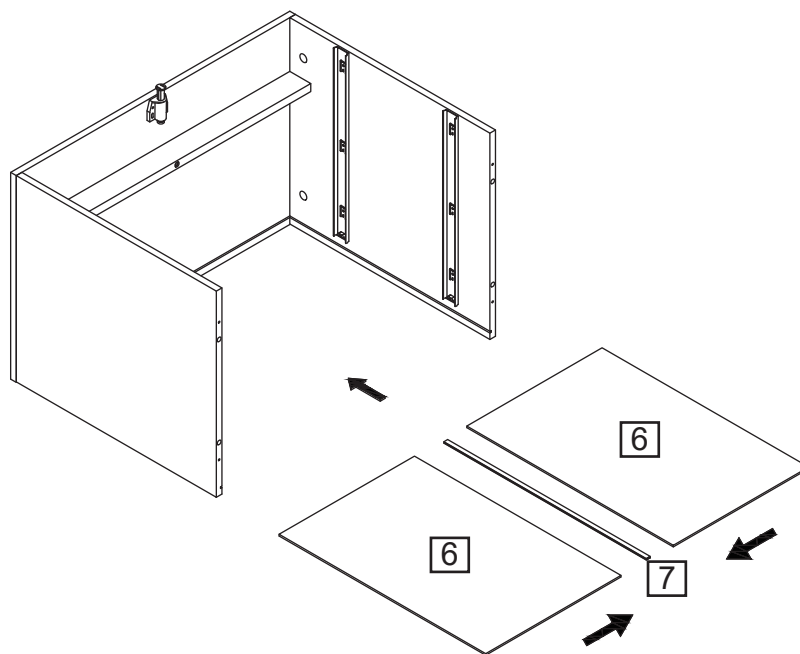

# Assembly Instructions

## Step 5

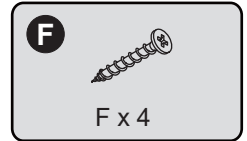
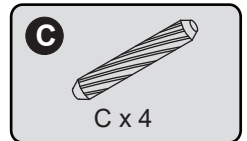
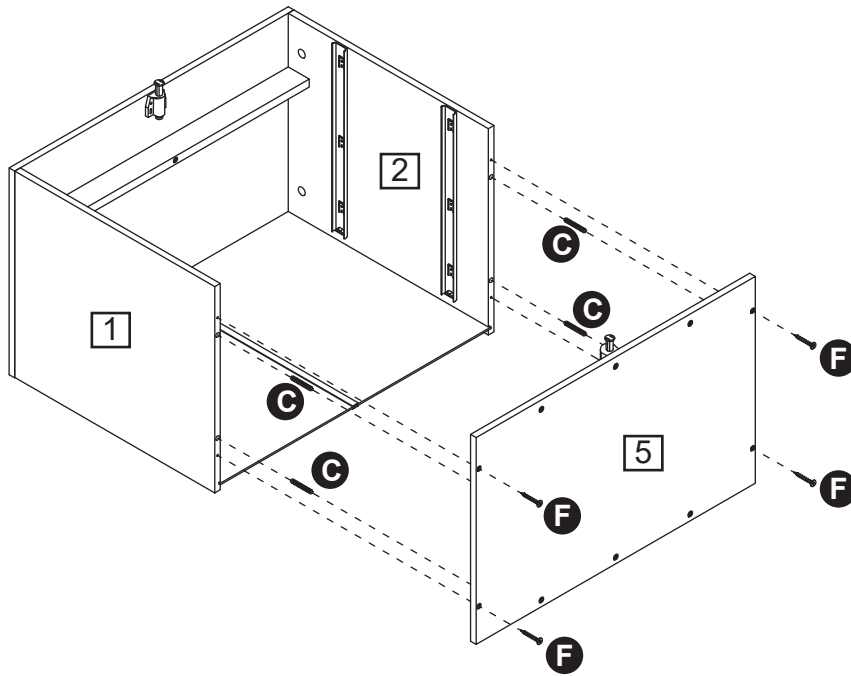

## Step 6

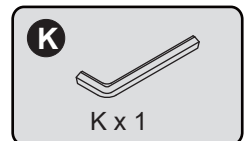
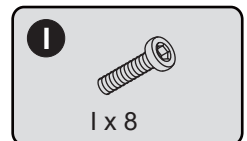
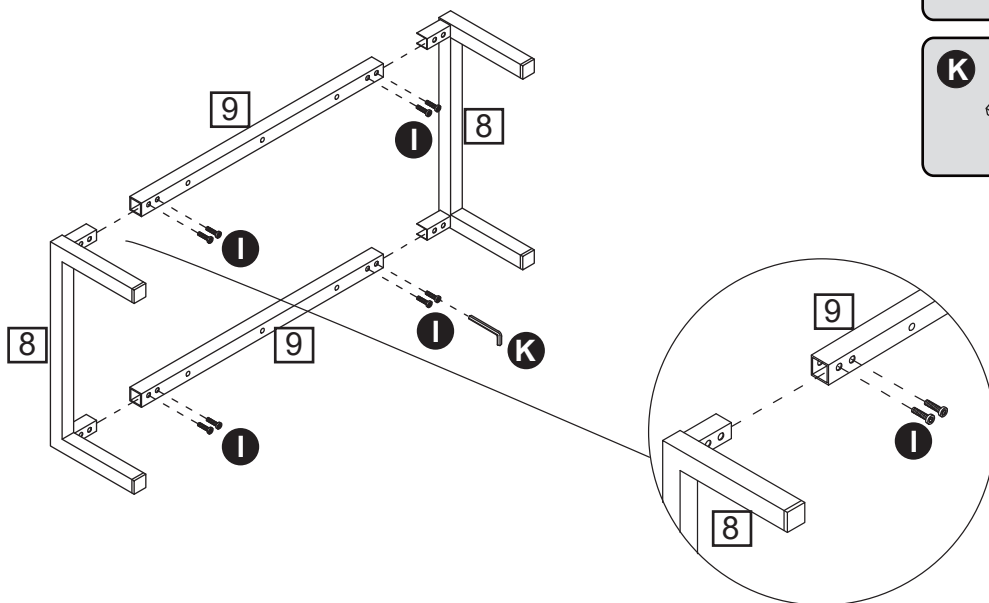

# Assembly Instructions

## Step 7

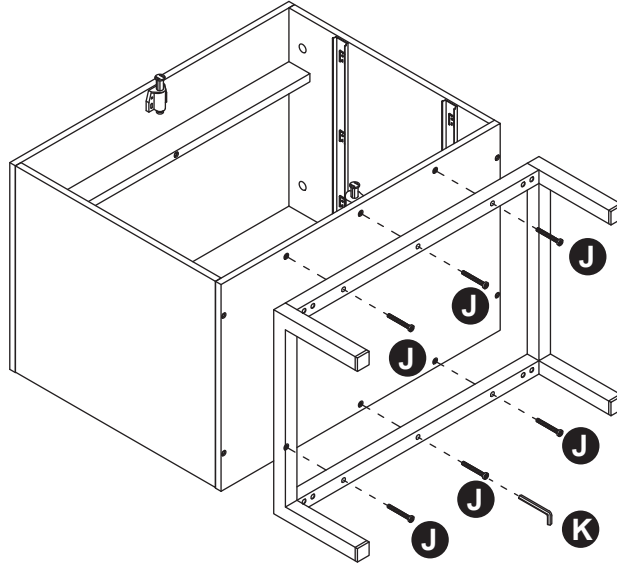
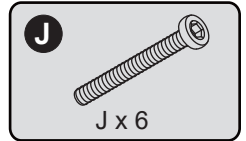

## Step 8

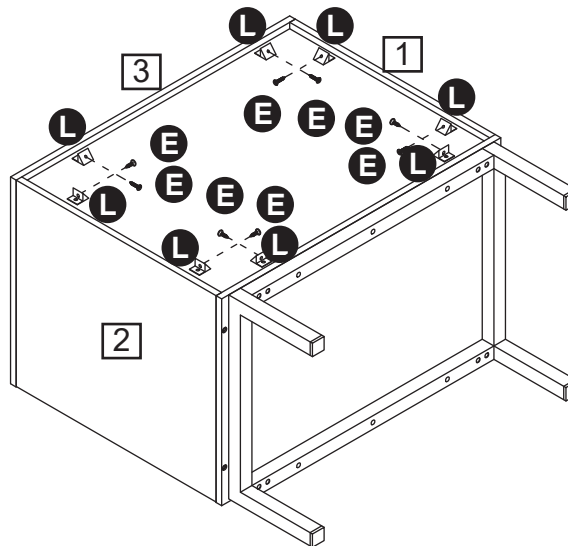
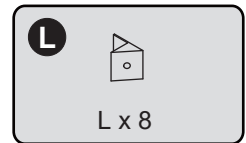
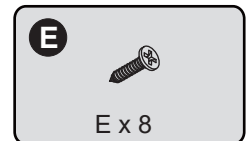

# Assembly Instructions

## Step 9

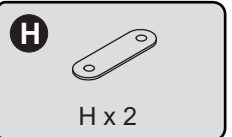
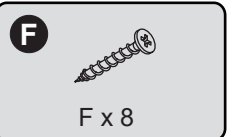
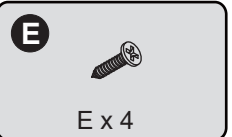
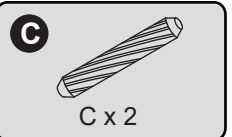
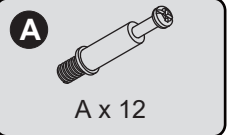
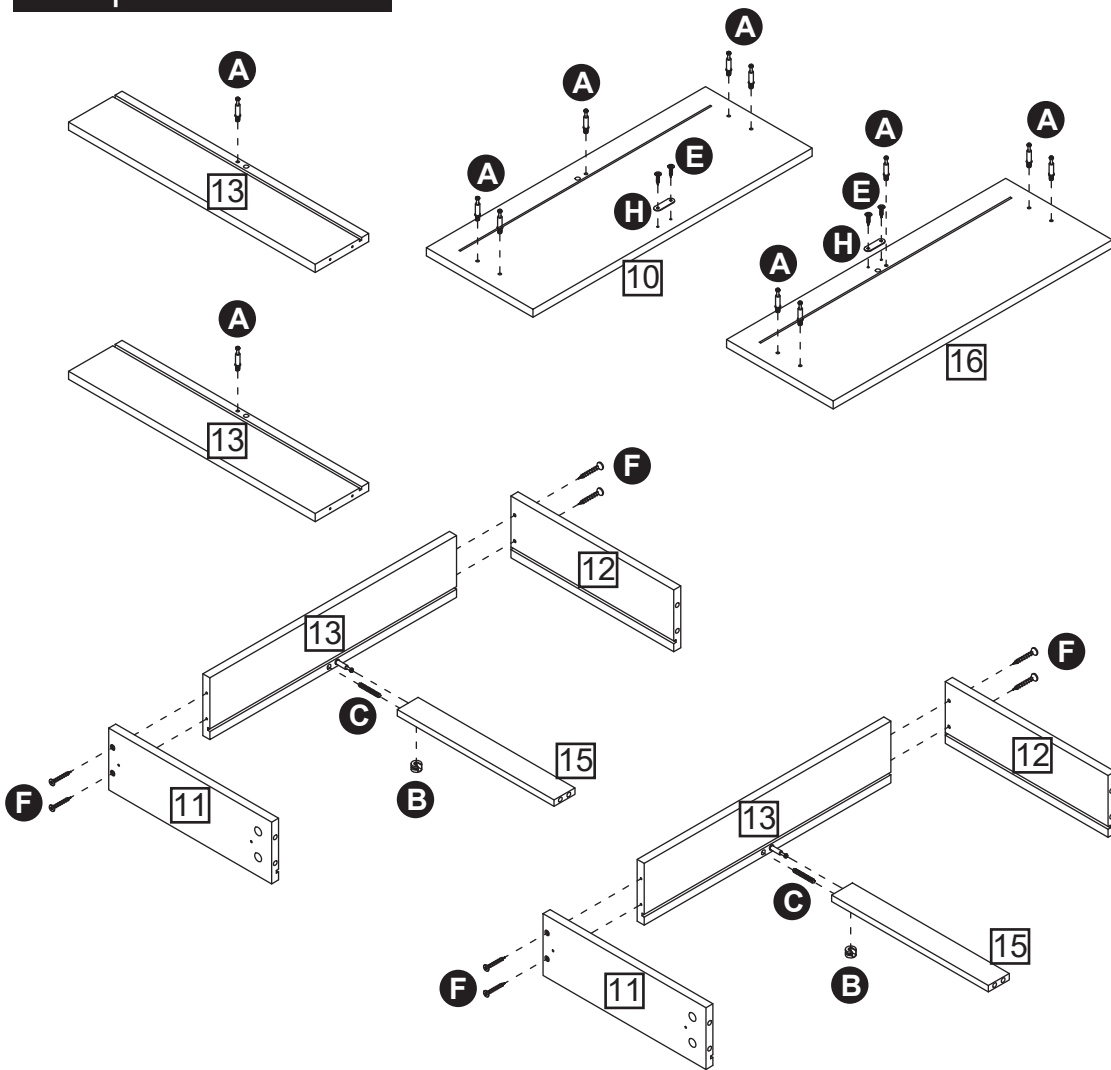

## Step 10

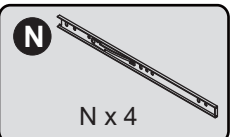
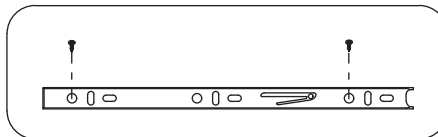
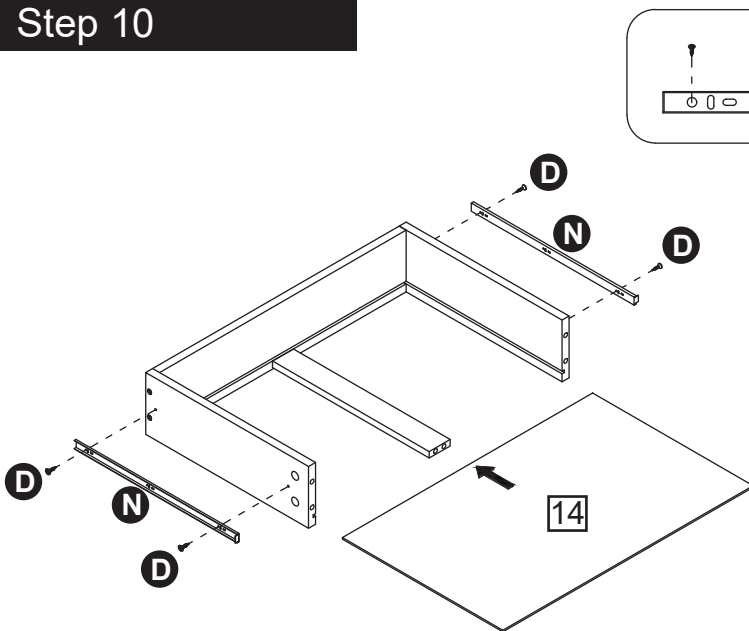

x 2

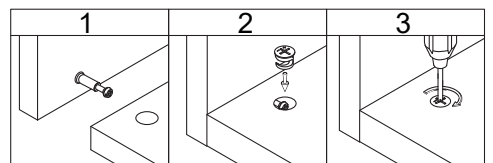

# Assembly Instructions

## Step 11

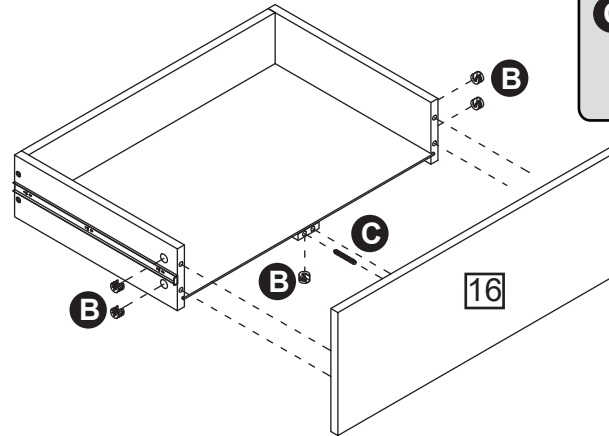
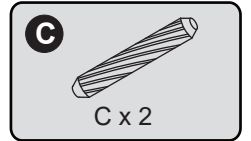
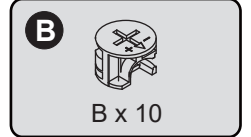
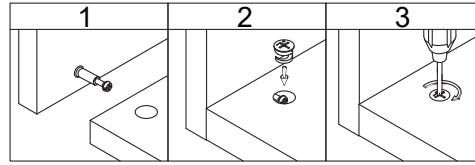
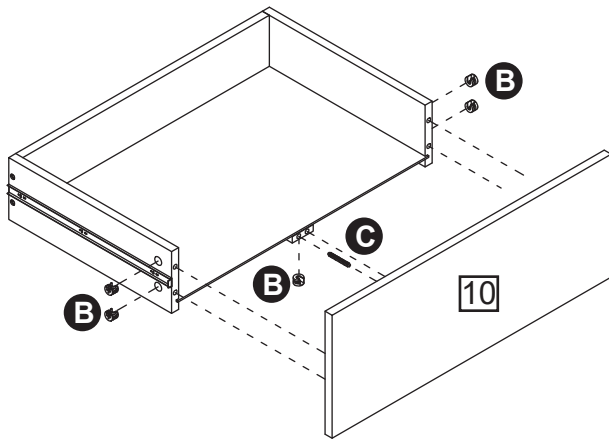

## Step 12

**⚠** It is highly recommended that the unit is secured to the wall. You can skip to the next step first, then come back to this step once the dresser is secured to the wall.

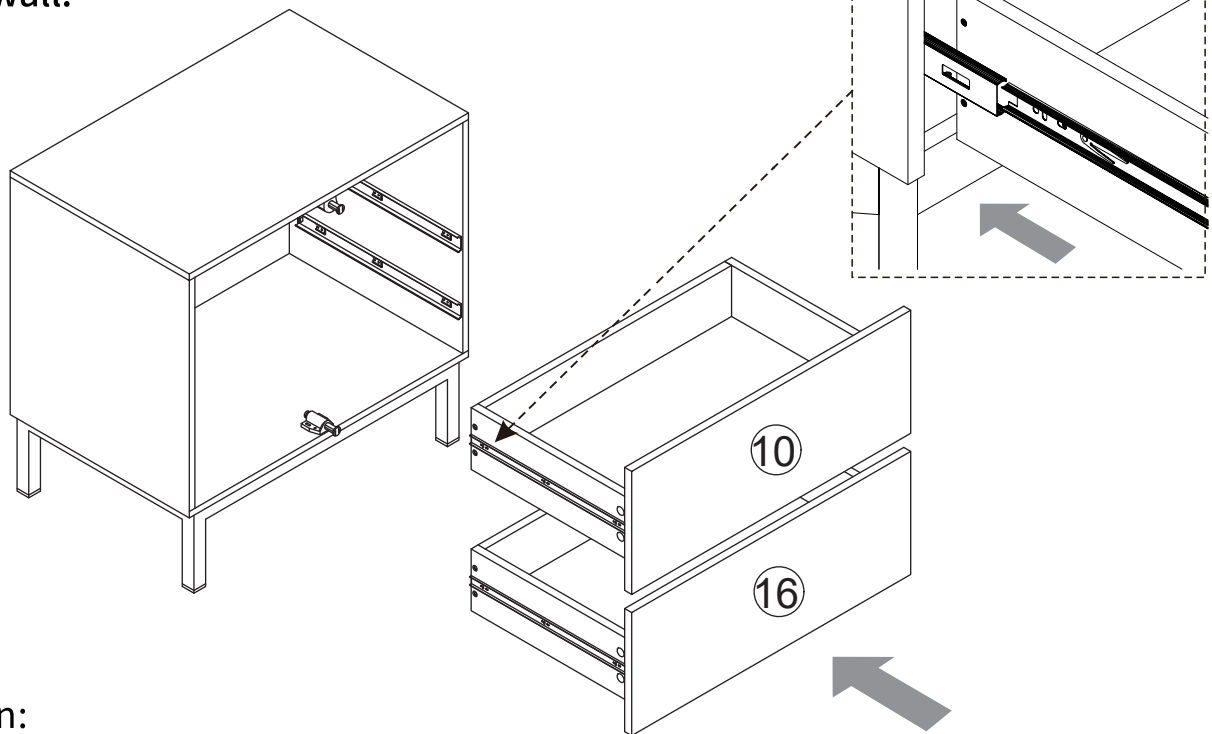

**Attention:**

1. Pull out the rail installed on the cabinet.
2. Align the slide runners on the drawer with the unit and push it carefully inside until it stops.

★ If the drawer does not go in smoothly please take it out and repeat the steps.