



**Amerlife**

Thank you for choosing Amerlife to be a part of your life. We value your business, and constantly strive to provide you only top-quality products and services. Contact us if we can be of further assistance, we'd love to hear your advice.

Our E-mail address: [support@wepatio.com](mailto:support@wepatio.com)



## Warm Tips:

1. If you need any help or received damaged or missing parts, please feel free to contact Amerlife customer support email: [support@wepatio.com](mailto:support@wepatio.com)
2. Please check the pack content before attempting to construct the greenhouse.
3. Read the manual carefully and familiarise yourself with the procedure before assembling it.
4. Please do not locate the product in the area exposed to excessive winds.
5. It is recommended that the greenhouse to be assembled by at least two people.



## WARNING

Manufacturer and seller expressly disclaim any and all liability for personal injury, property damage, or loss, whether direct, indirect, or incidental, resulting from the incorrect attachment, improper use, inadequate maintenance, or neglect of this product.

# 20x10x7.5 ft Greenhouse

## INSTRUCTION MANUAL



Amerlife

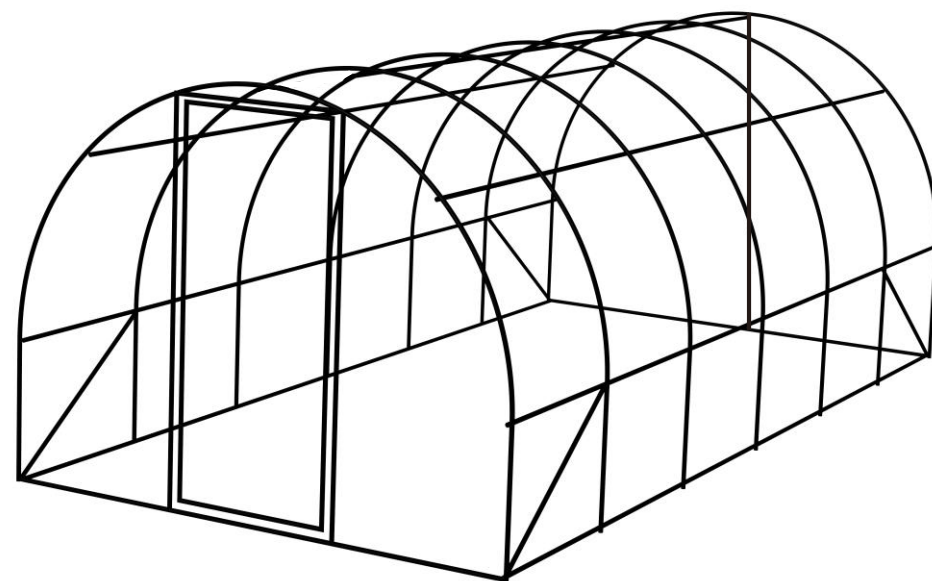

**SKU:1007030011D**

Email: [support@wepatio.com](mailto:support@wepatio.com)

Phone: 901-347-2181

Revision date: 23.6.12

# Accessories List

## STEP 6

To make the greenhouse more sturdy, after assemble the cover install the pressed film clips according to the marked points in the picture.

NO.	1	2	3	4	5	6	7	8	9	10
	1550mm	1021mm	1021mm	1008mm	1021mm	1150mm	550mm	550mm	1021mm	1190mm
	21PCS	6PCS	30PCS	4PCS	2PCS	4PCS	7PCS	7PCS	1PCS	2PCS

11	12	13	14	15	16	17	18	S1	S2	S3
455mm	1480mm	455mm	1480mm	1480mm	1480mm	980mm	1100mm			
1PCS	1PCS	1PCS	1PCS	1PCS	1PCS	6PCS	1PCS	3PCS	2PCS	2PCS

S4	S5	S6	F4	F3	F5	I	T	A	J1	J2
3PCS	7PCS	2PCS	42PCS	18PCS	60PCS	1PCS	1PCS	24PCS	12PCS	12PCS

PE	Door PE Cover	G	B2	D1	D	C	K	H		
1PCS	1PCS	1PCS	60PCS	60PCS	2PCS	2PCS	12PCS	2PCS		

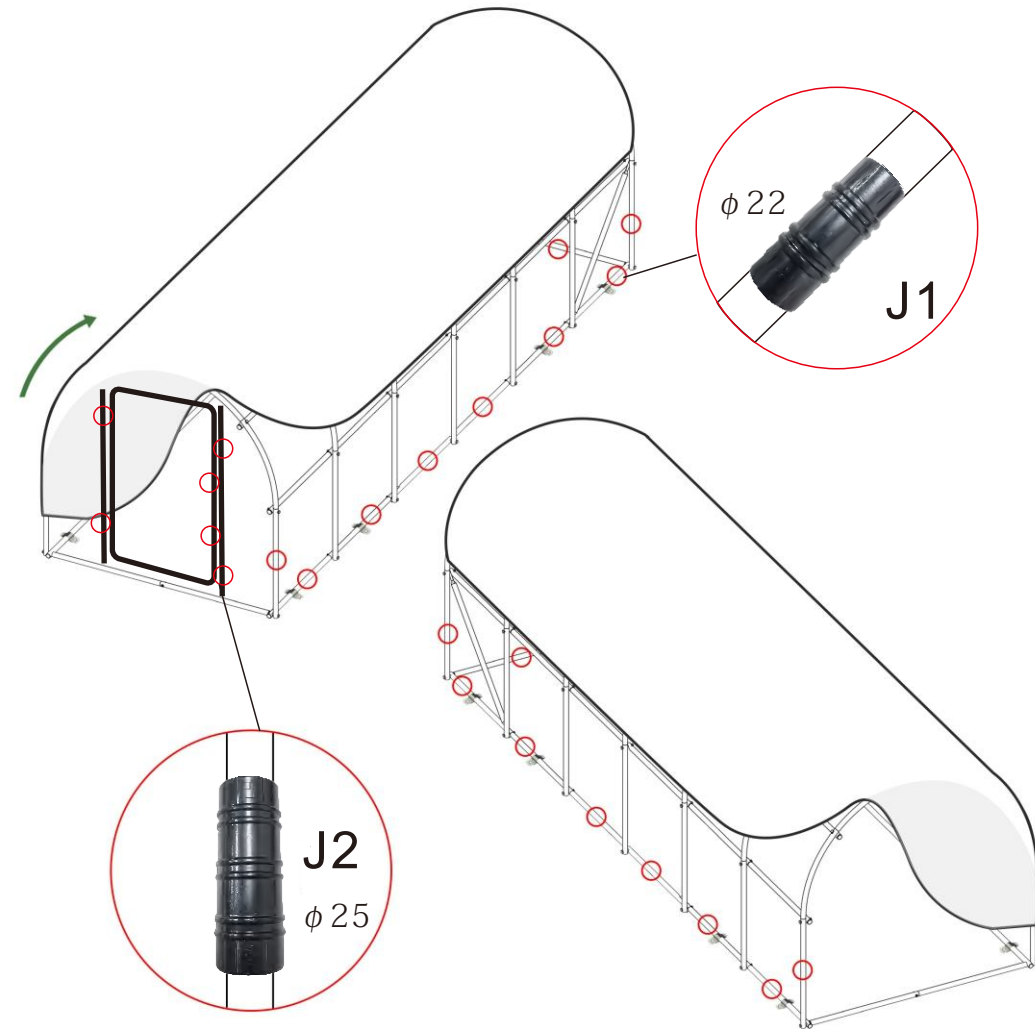

How to make the whole greenhouse more solid in strong wind or snow?

1. Make all the screws in perfectly fixed status
2. Use the buckle and ground pegs included
3. Dig a trench at the bottom of the frame, and bury the bottom steel pipe and cover with soil (this way is very efficient)
4. Let the whole greenhouse against the wall
5. Keep the door closed when not using

## HARDWARE

part List	Qty
J1	12
J2	12

## STEP5

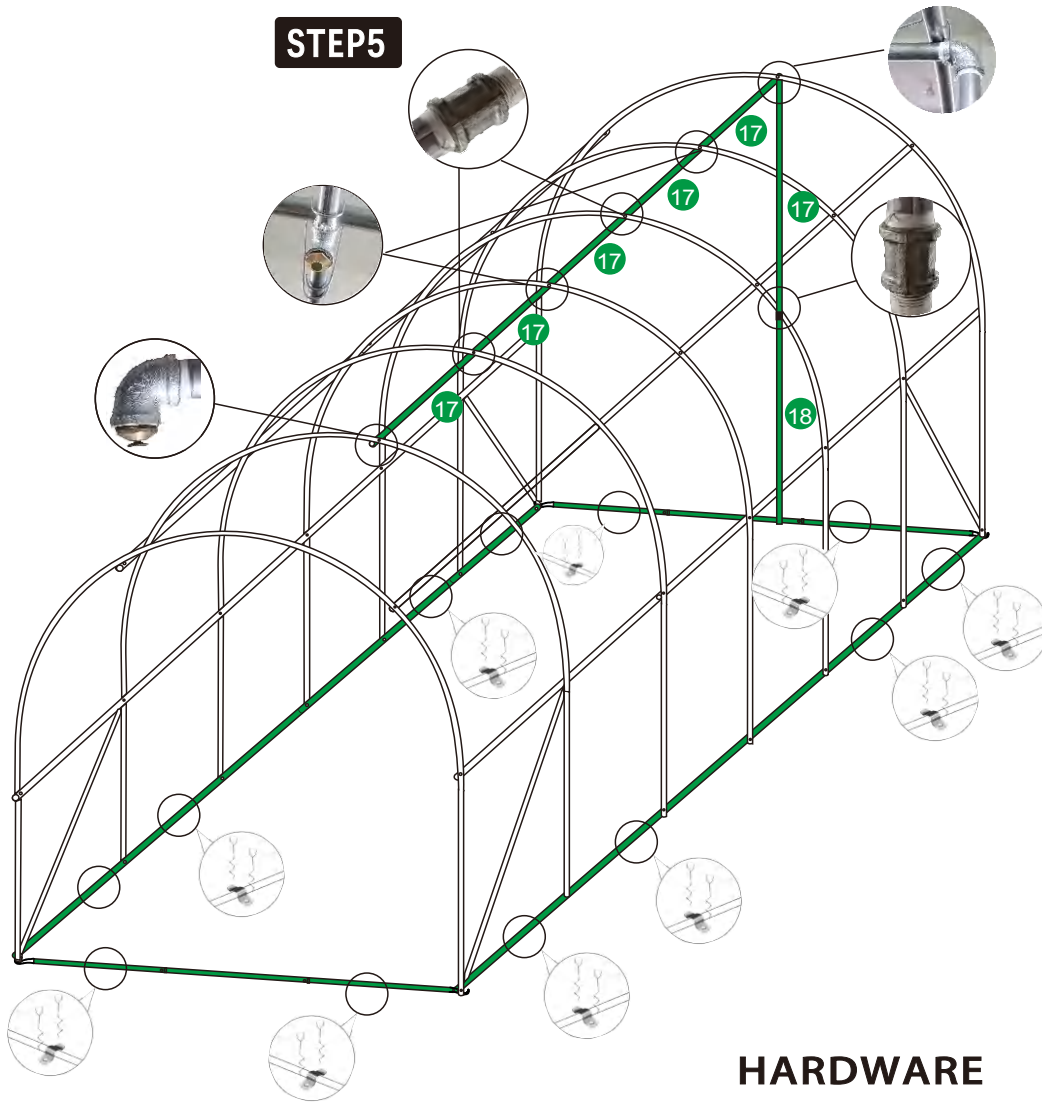

## HARDWARE

Part List	Picture	Qty	Part List	Picture	Qty
A		24	S3		2
K		12	S2		2
S4		3	S1		3
S5		7	S6		2

# Assembly Instruction

## •Steel Pipe

Assemble four curved supports with **longer** bolts (Insert for preliminary fixation only, and tighten later).

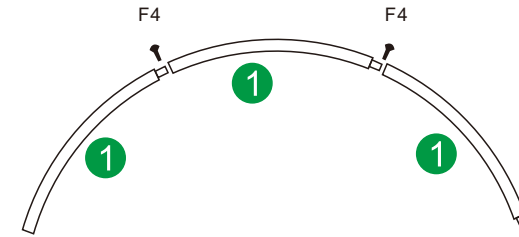

Assemble horizontal supports with longer bolts (Insert for preliminary fixation only, and tighten later).

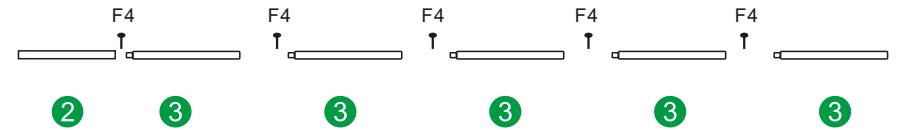

## • Frame

Put two floor supports(short) and two horizontal supports' (long) together.

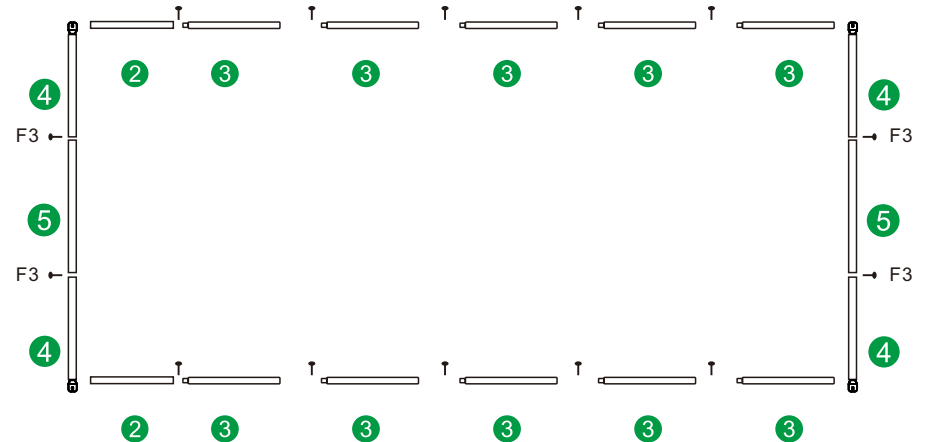

# HARDWARE

Part List	Picture	Qty	Part List	Picture	Qty
2		2	7		7
3		10	8		7
4		4	F3		4
5		2	F4		14
6		4	F5		18

## STEP 1

Assemble parts 2,3,4,5,6 into a rectangle as shown in the figure below. No.7 and No.8 should be used on the different side. Pay attention to the direction of No.7 and the direction with the shrinking tube is upward. Note that the pipe head should be placed in the middle of the two pipes.

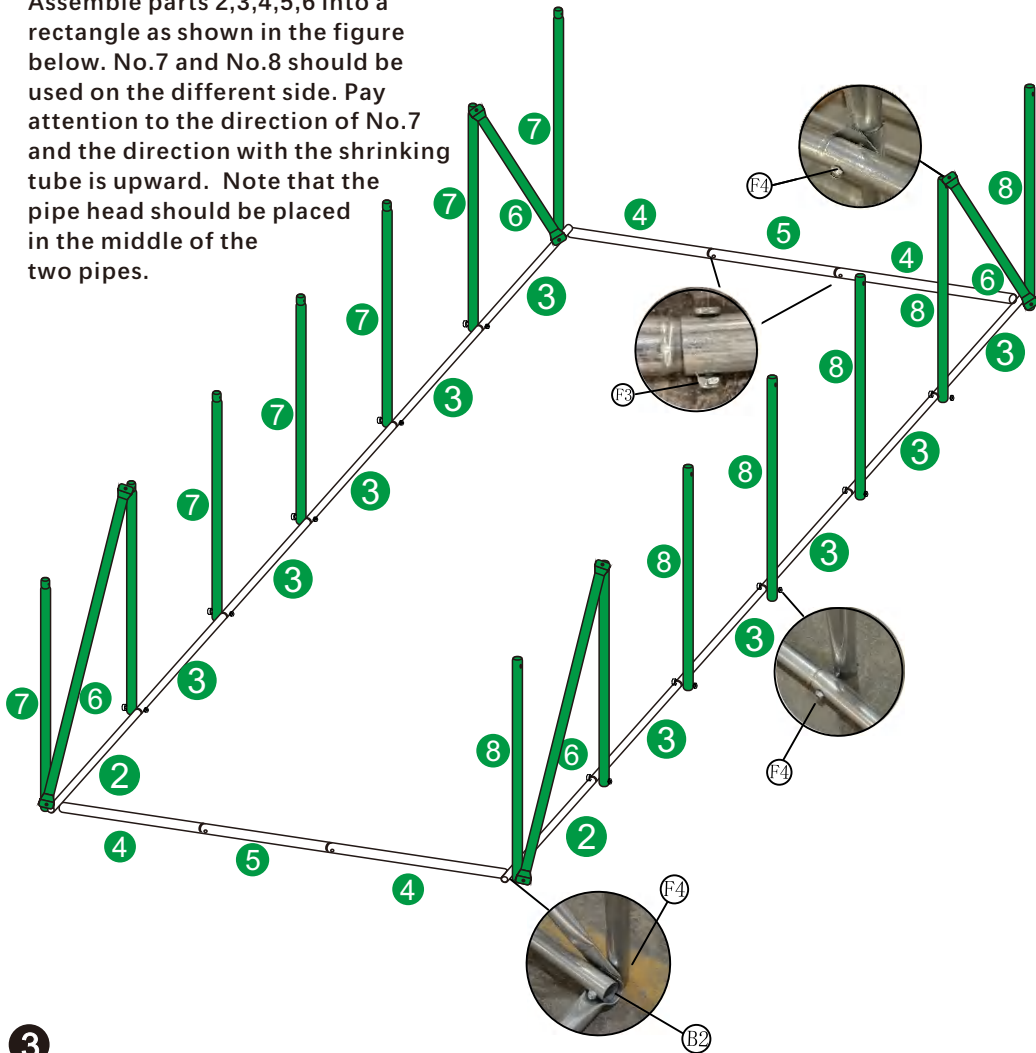

# HARDWARE

Part List	Picture	Qty	Part List	Picture	Qty
G		1	D		2
H		2	F3		4
Door PE Cover		1	F5		4

## STEP 4-3



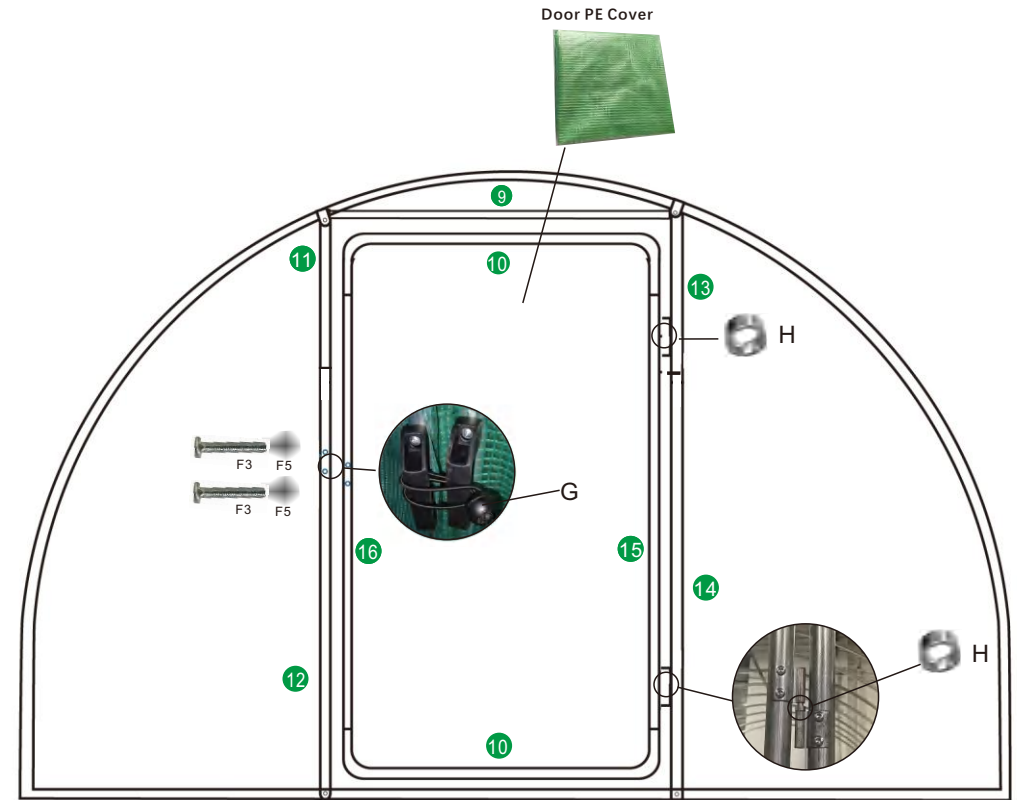

4-3: Put the door to the door frame; Use H accessory to connect the 2 hinged parts.

Install the door handle(D part), fix it with 4 F3 Screws

If not clear, please contact [support@wepatio.com](mailto:support@wepatio.com) for detailed installation video



# HARDWARE



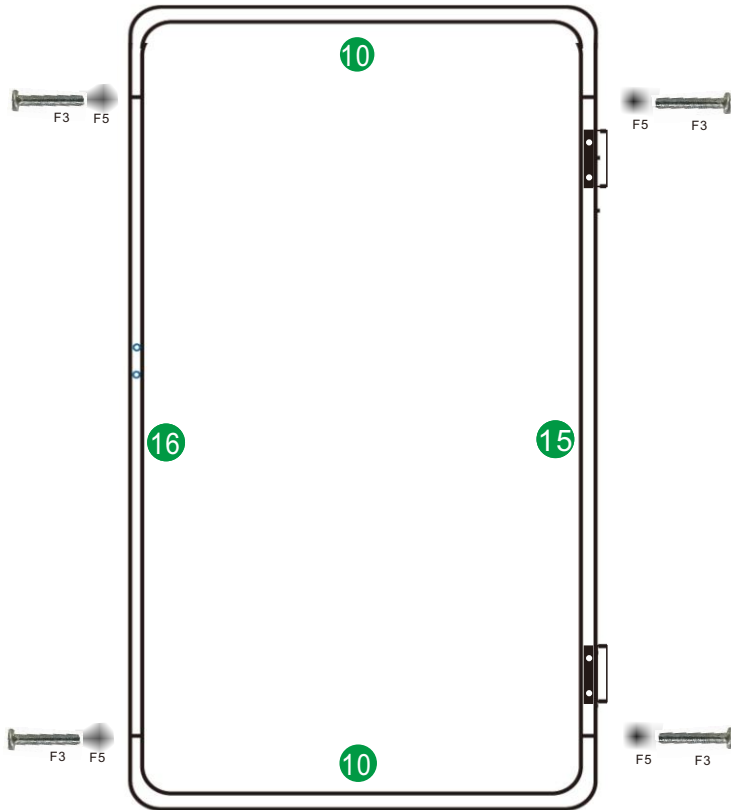

Part List	Picture	Qty	Part List	Picture	Qty
10		2	F3		4
15		1	F5		4
16		1			



## STEP 4-2

4-2: install the door: assemble parts 10 (2) , 15 , 16 ; connected by F3 Screw.  
 Put the door PE cover to the door, open part at right (15)side.  
 Notice: Need to cut some cloth out at hinged parts for beauty and better seal.  
 The location of film clips J refers to STEP 6

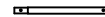
# HARDWARE

Part List	Picture	Qty
1		28
2		2
3		10
F4		28
F5		14

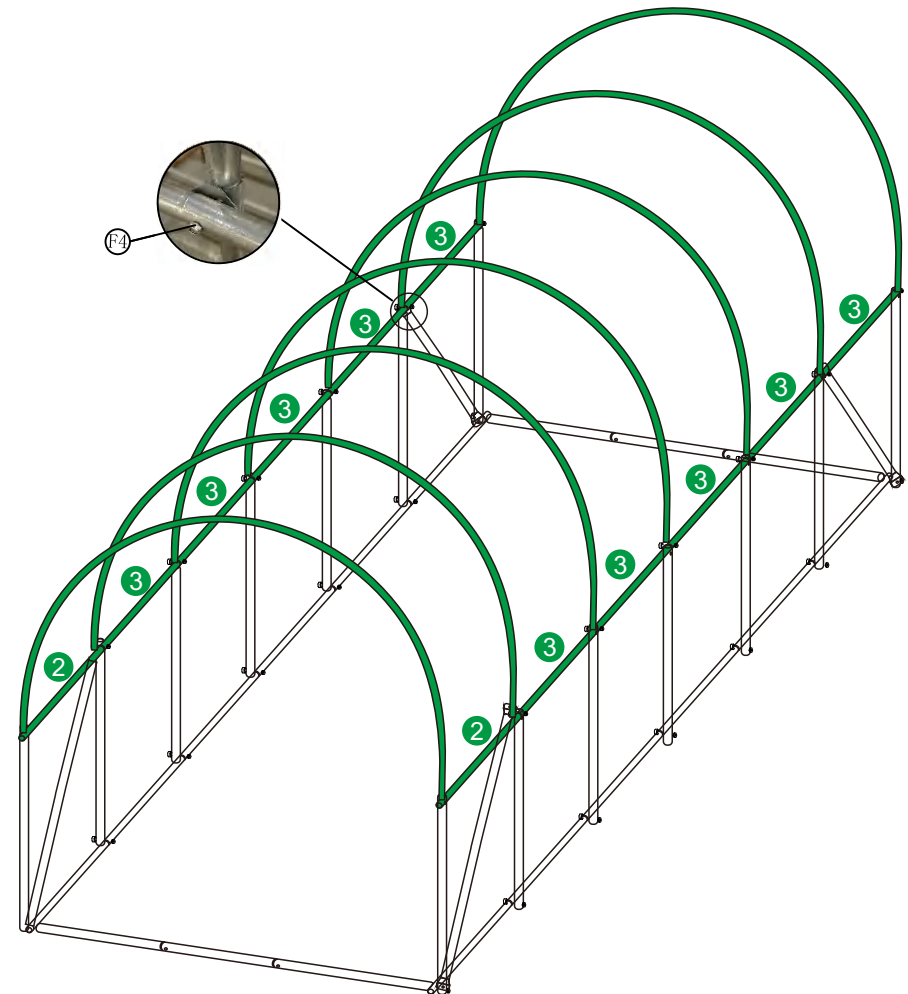

## STEP 2

Install curved supports with NO.2 and NO.3 parts, as shown the figure below, and connect them with screws.





# HARDWARE







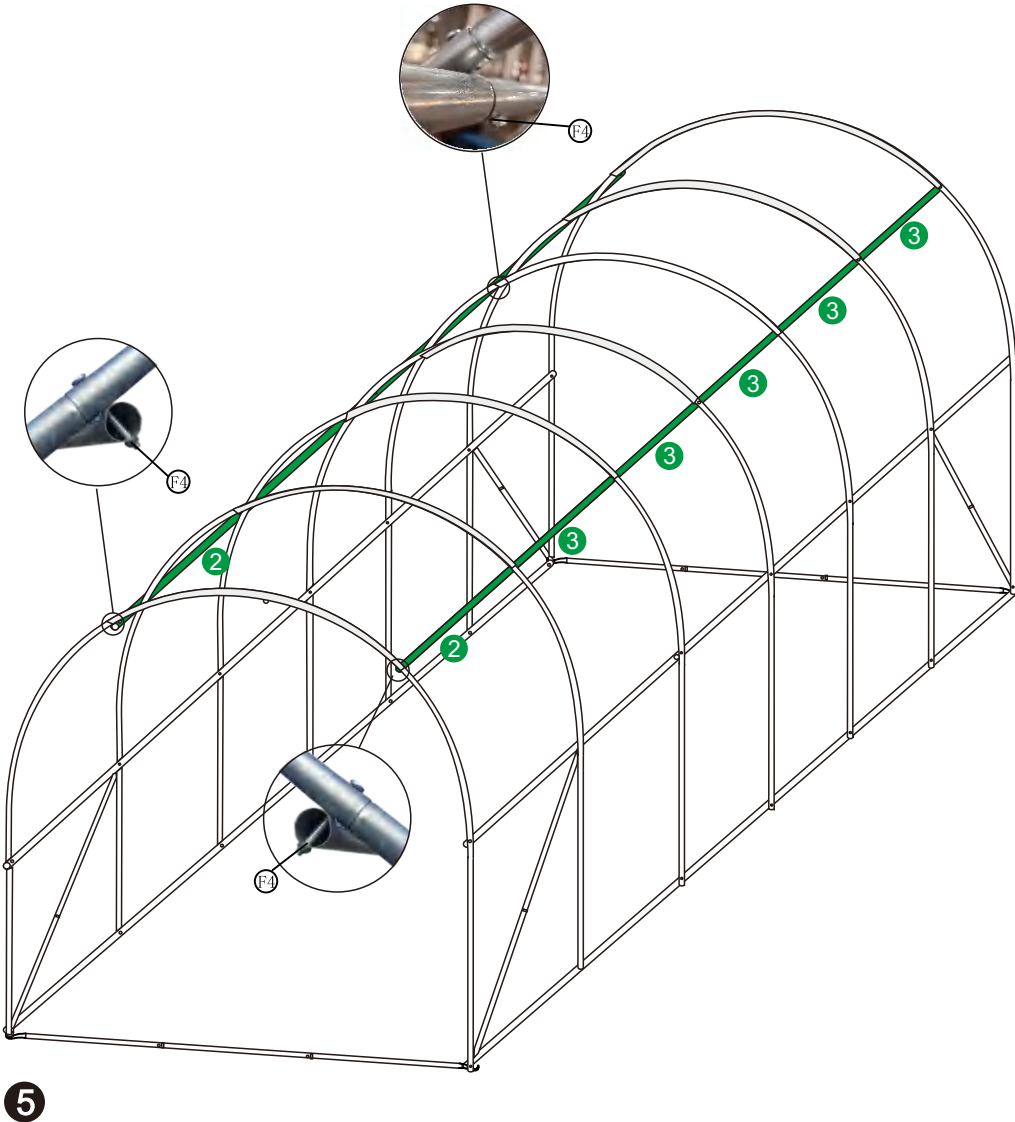

Part List	Picture	Qty
2		2
3		10
F5		14

## STEP 3

Use 2 pcs of No.2 parts and 10pcs of No.3 parts to form as shown in the figure below, and connect them with screws. Note that parts should be used on the same side.



# HARDWARE

Part List	Picture	Qty	Part List	Picture	Qty
9		1	12		1
13		1	C		2
14		1	F3		4
11		1	F5		4

## STEP 4-1

4-1: install the door frame: assemble parts 11, 12, 13, 14, 9, the top of frame is fixed by accessory C

