



Amerlife

Thank you for choosing Amerlife to be a part of your life. We value your business, and constantly strive to provide you only top-quality products and services. Contact us if we can be of further assistance, we'd love to hear your advice.

Our E-mail address: support@wepatio.com



Warm Tips:

1. If you need any help or received damaged or missing parts, please feel free to contact Amerlife customer support email: support@wepatio.com
2. Please check the pack content before attempting to construct the greenhouse.
3. Read the manual carefully and familiarise yourself with the procedure before assembling it.
4. Please do not locate the product in the area exposed to excessive winds.
5. It is recommended that the greenhouse to be assembled by at least two people.



WARNING

Manufacturer and seller expressly disclaim any and all liability for personal injury, property damage, or loss, whether direct, indirect, or incidental, resulting from the incorrect attachment, improper use, inadequate maintenance, or neglect of this product.

28x10x7.5 ft Greenhouse

INSTRUCTION MANUAL

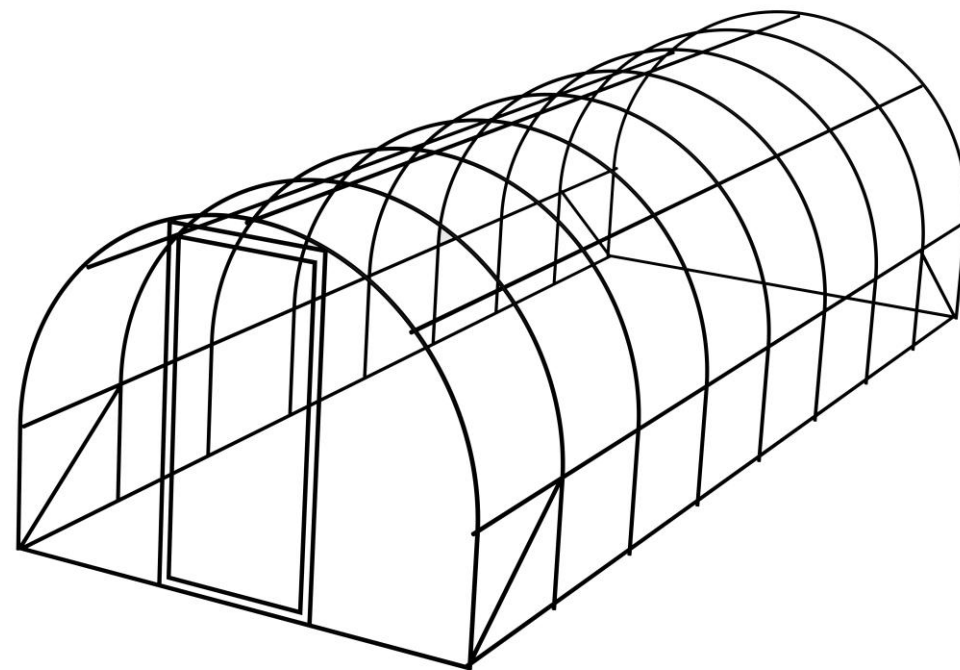

SKU:1007030010D

Email: support@wepatio.com

Phone: 901-347-2181

Revision date: 22.04.27

Accessories List

NO.	1	2	3	4	5	6	6-1	7	8
	1130mm	1085mm	1085mm	1008mm	1021mm	985mm	425mm	880mm	880mm
	36PCS	7PCS	49PCS	4PCS	2PCS	4PCS	4PCS	9PCS	9PCS

9	10	11	12	13	14	15	16	17	18
1021mm	1190mm	900mm	900mm	900mm	900mm	1100mm	1100mm	1100mm	1100mm
1PCS	2PCS	1PCS	1PCS	1PCS	1PCS	1PCS	1PCS	1PCS	1PCS

H	G	B2	F4	F3	F5	I	T	A	J
2PCS	1PCS	14PCS	63PCS	22PCS	85PCS	1PCS	1PCS	28PCS	28PCS

P E	Door PE Cover	D1	D	C	K
1PCS	1PCS	85PCS	2PCS	2PCS	14PCS

STEP 6

To make the greenhouse more sturdy, after assemble the cover install the pressed film clips according to the marked points in the picture.

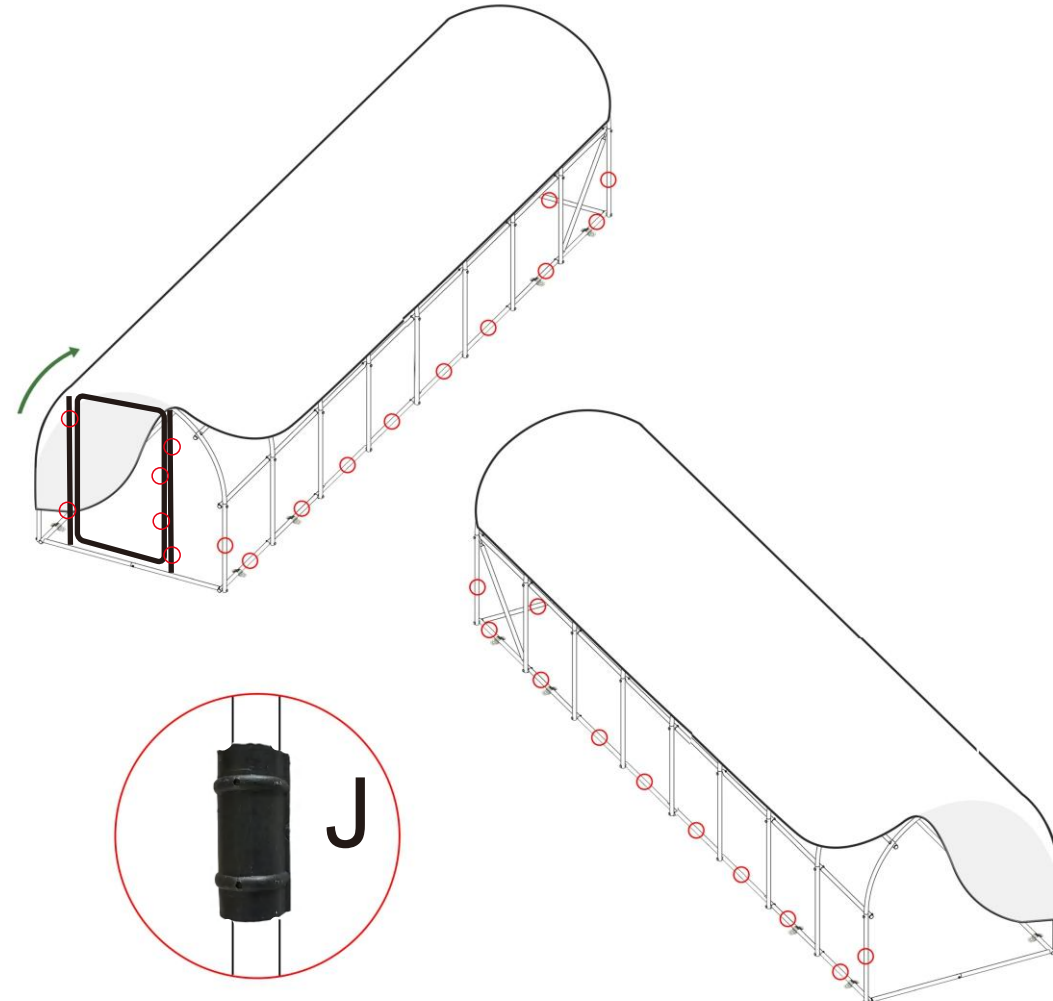

How to make the whole greenhouse more solid in strong wind or snow?

1. Make all the screws in perfectly fixed status
2. Use the buckle and ground pegs included
3. Dig a trench at the bottom of the frame, and bury the bottom steel pipe and cover with soil (this way is very efficient)
4. Let the whole greenhouse against the wall
5. Keep the door closed when not using

HARDWARE

part List	Qty
J	28

STEP5

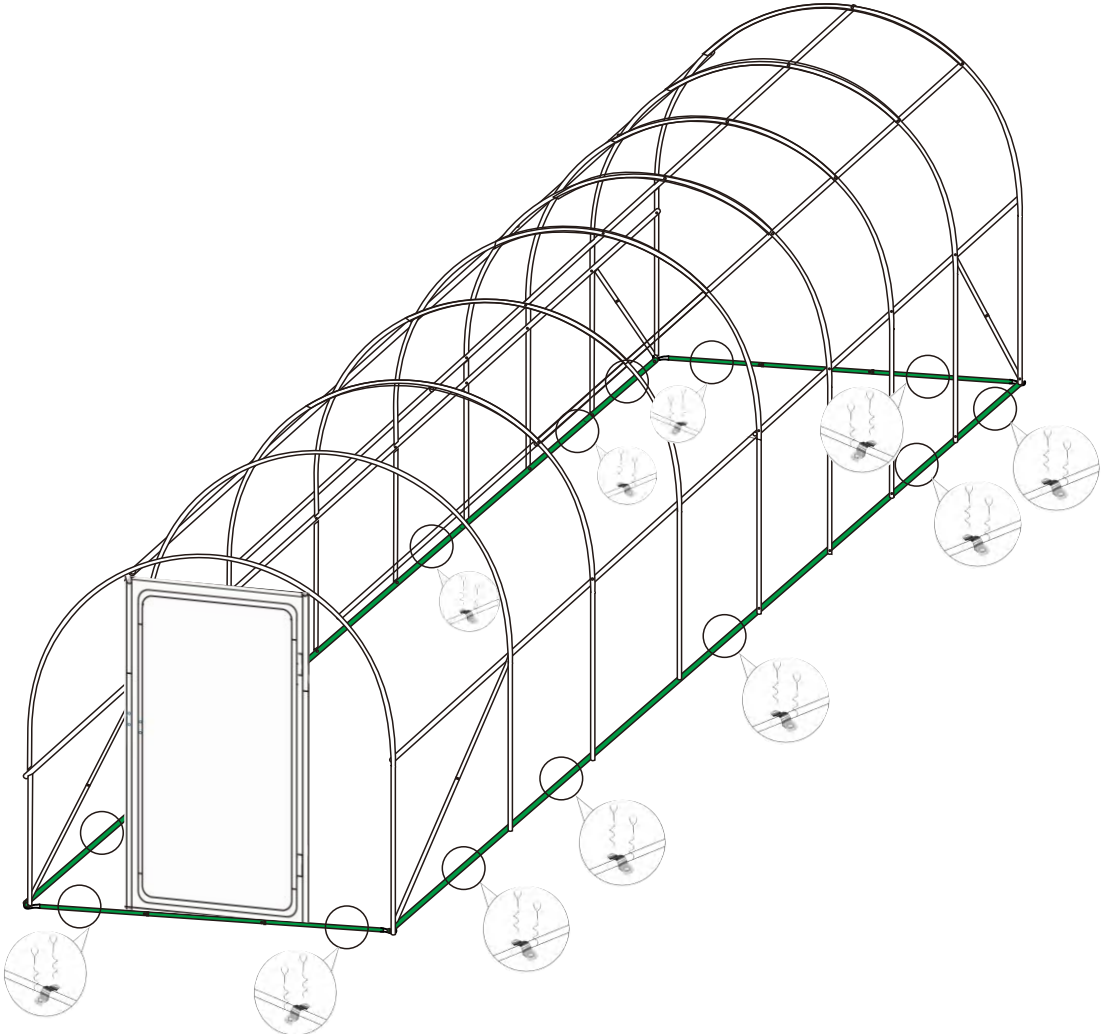

HARDWARE

Part List	Picture	Qty
A		28
K		14

Assembly Instruction

•Steel Pipe

Assemble four curved supports with **longer bolts** (Insert for preliminary fixation only, and tighten later).

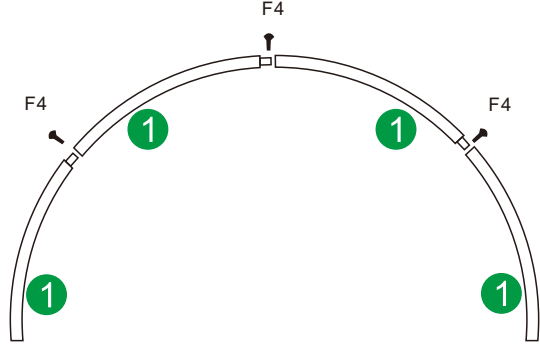

Assemble horizontal supports with longer bolts (Insert for preliminary fixation only, and tighten later).



• Frame

Put two floor supports(short) and two horizontal supports' (long) together.

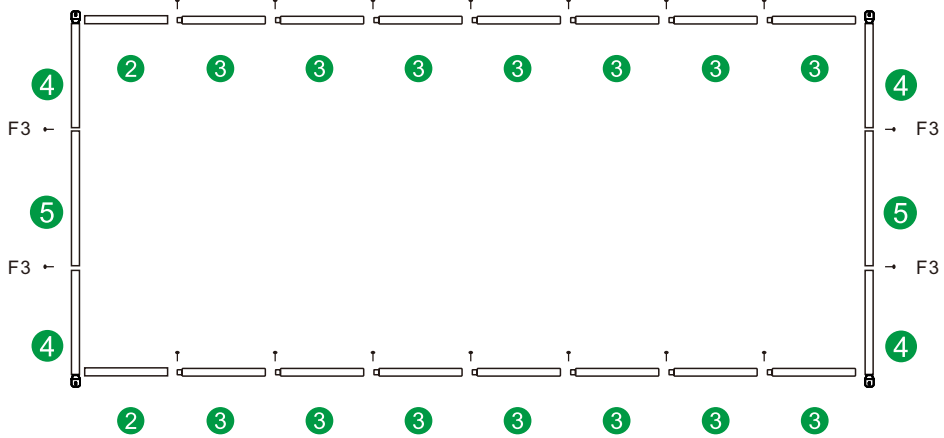

HARDWARE

Part List	Picture	Qty	Part List	Picture	Qty
2		2	6-1		4
3		14	7		9
4		4	8		9
5		2	F3		8
6		4	F4		18

STEP 1

Assemble parts 2, 3, 4, 5, 6, and 6-1 into a rectangle as shown in the figure below. No. 7 and No. 8 should be used on the same side. Pay attention to the direction of No. 7 and the direction with the shrinking tube is upward. Connect No. 6, and 6-1 as shown in the figure below. Note that the pipe head should be placed in the middle of the two pipes.

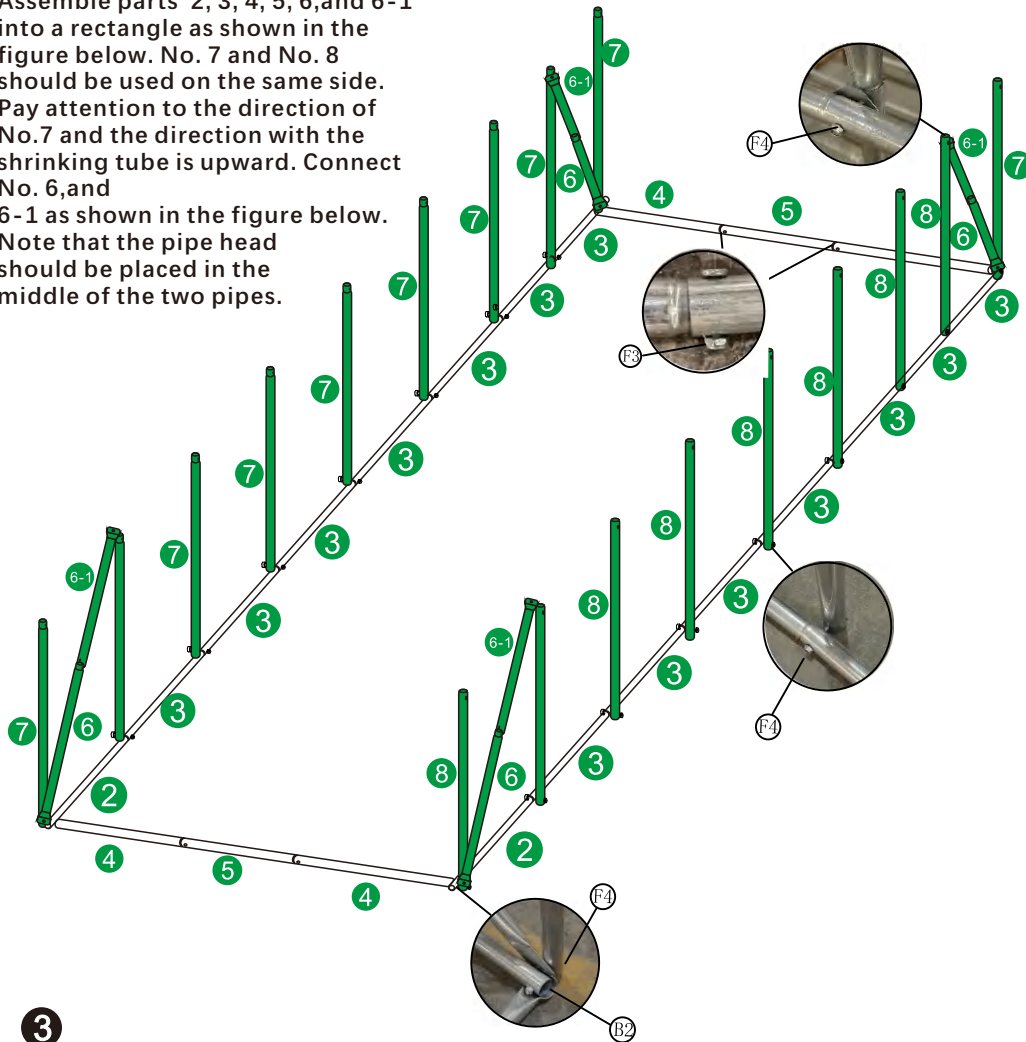

HARDWARE

Part List	Picture	Qty	Part List	Picture	Qty
G		1	D		2
H		2	F3		4
Door PE Cover		1	F5		4

STEP 4-3

4-3: Put the door to the door frame; Use H accessory to connect the 2 hinged parts.

Install the door handle(D part), fix it with 4 F3 Screws

If not clear, please contact support@wepatio.com for detailed installation video

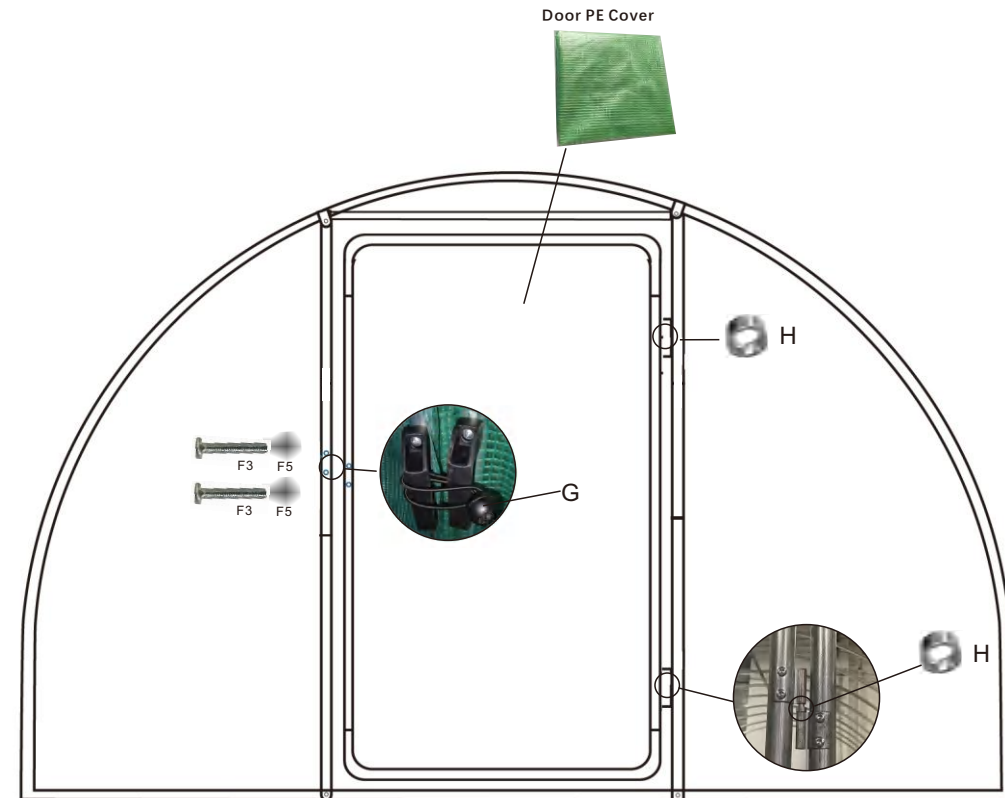

HARDWARE

Part List	Picture	Qty	Part List	Picture	Qty
10		2	14		1
11		1	F3		6
12		1	F5		6
13		1			

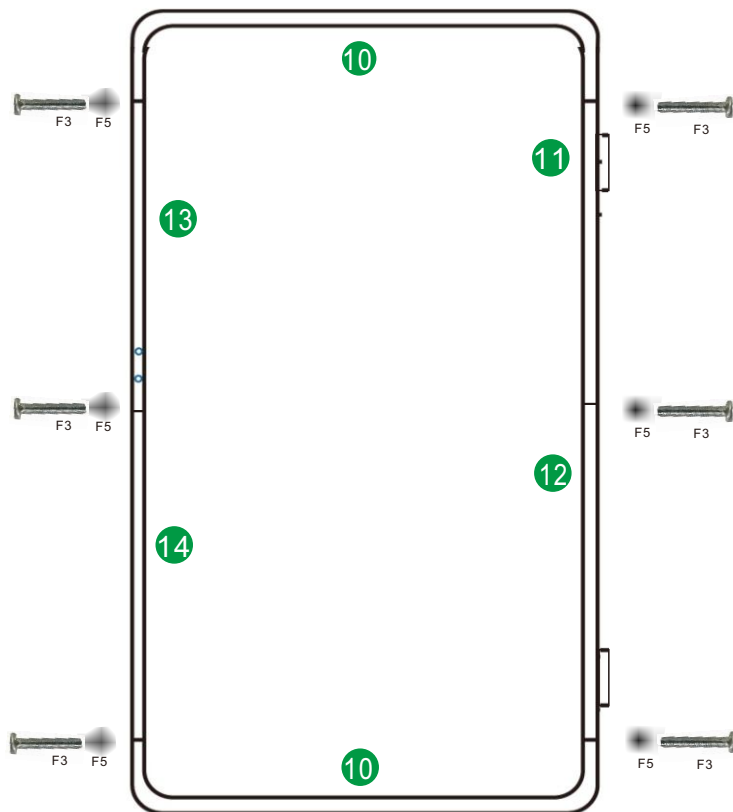

STEP 4-2

4-2: install the door: assemble parts 10 (2) , 11, 12, 13, 14; connected by F3 Screw.

Put the door PE cover to the door, open part at right (11,12)side.

Notice: Need to cut some cloth out at hinged parts for beauty and better seal.

The location of film clips J refers to STEP 6

HARDWARE



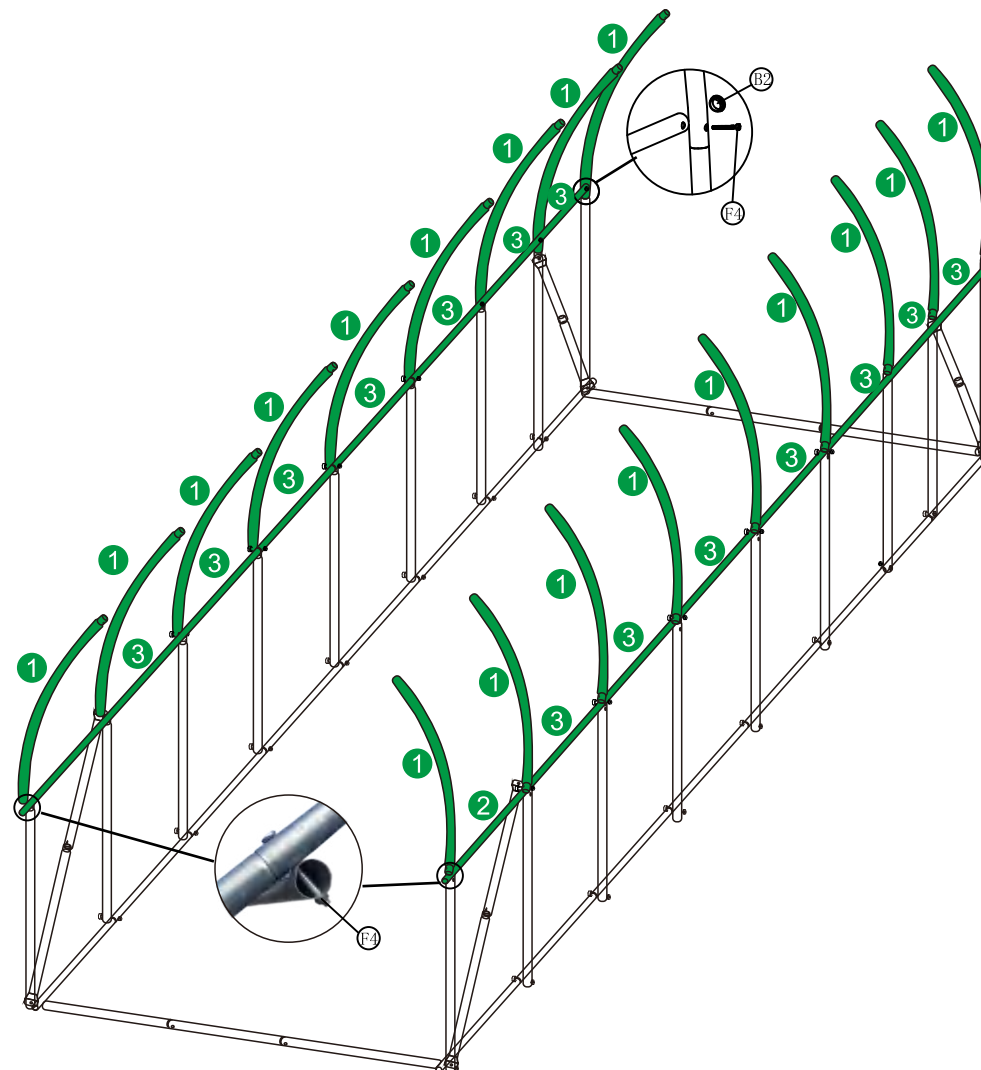

Part List	Picture	Qty
1		18
2		2
3		14
F4		18
F5		18

STEP 2

Use 18 pcs of No.1 parts, 2 pcs of No.2 parts and 14 pcs of No.3 parts to form, as shown the figure below, and connect them with screws.



HARDWARE





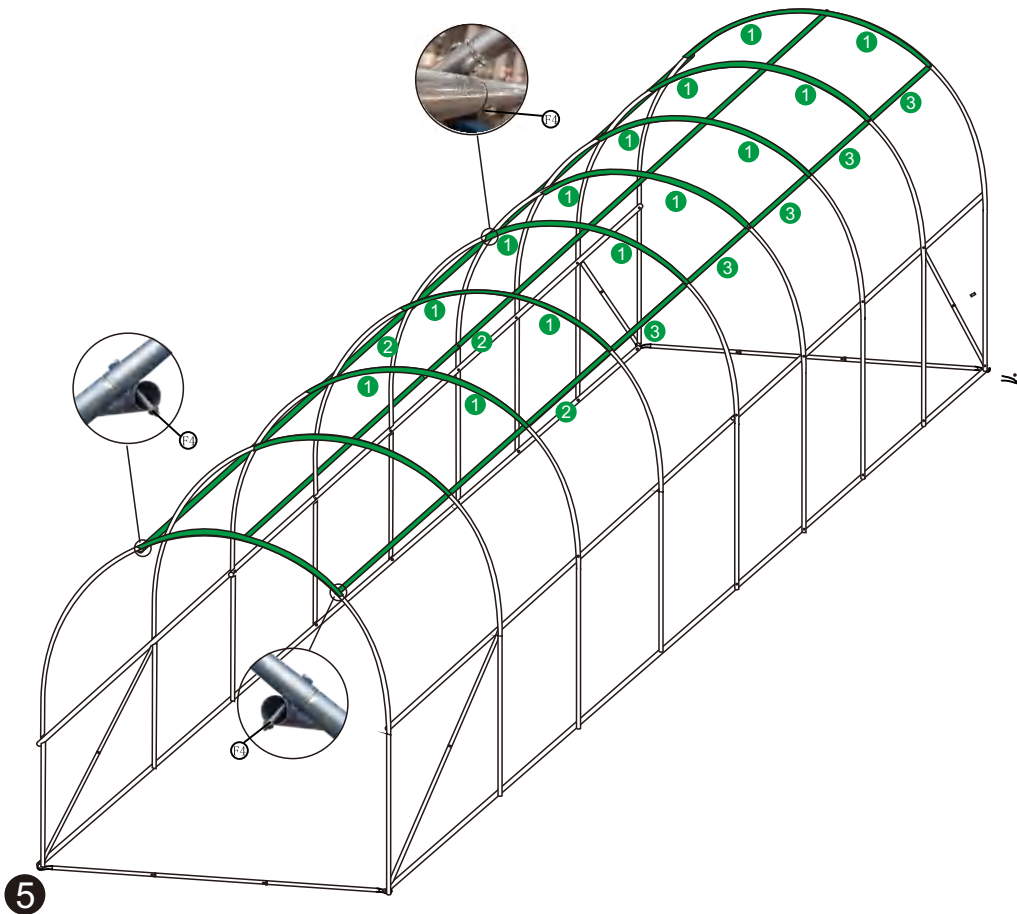

Part List	Picture	Qty
1		18
2		3
3		21
F4		27
F5		27

STEP 3

Use 18 pcs of No.1 parts, 3 pcs of No.2 parts and 21 pcs of No.3 parts to form as shown in the figure below, and connect them with screws. Note that parts should be used on the same side.



HARDWARE

Part List	Picture	Qty	Part List	Picture	Qty
9		1	18		1
15		1	C		2
16		1	F3		4
17		1	F5		4

STEP 4-1

4-1: install the door frame: assemble parts 15, 16, 17, 18, 9, the top of frame is fixed by accessory C

