

CONTEMPORARY SOFA

Assembly Instruction

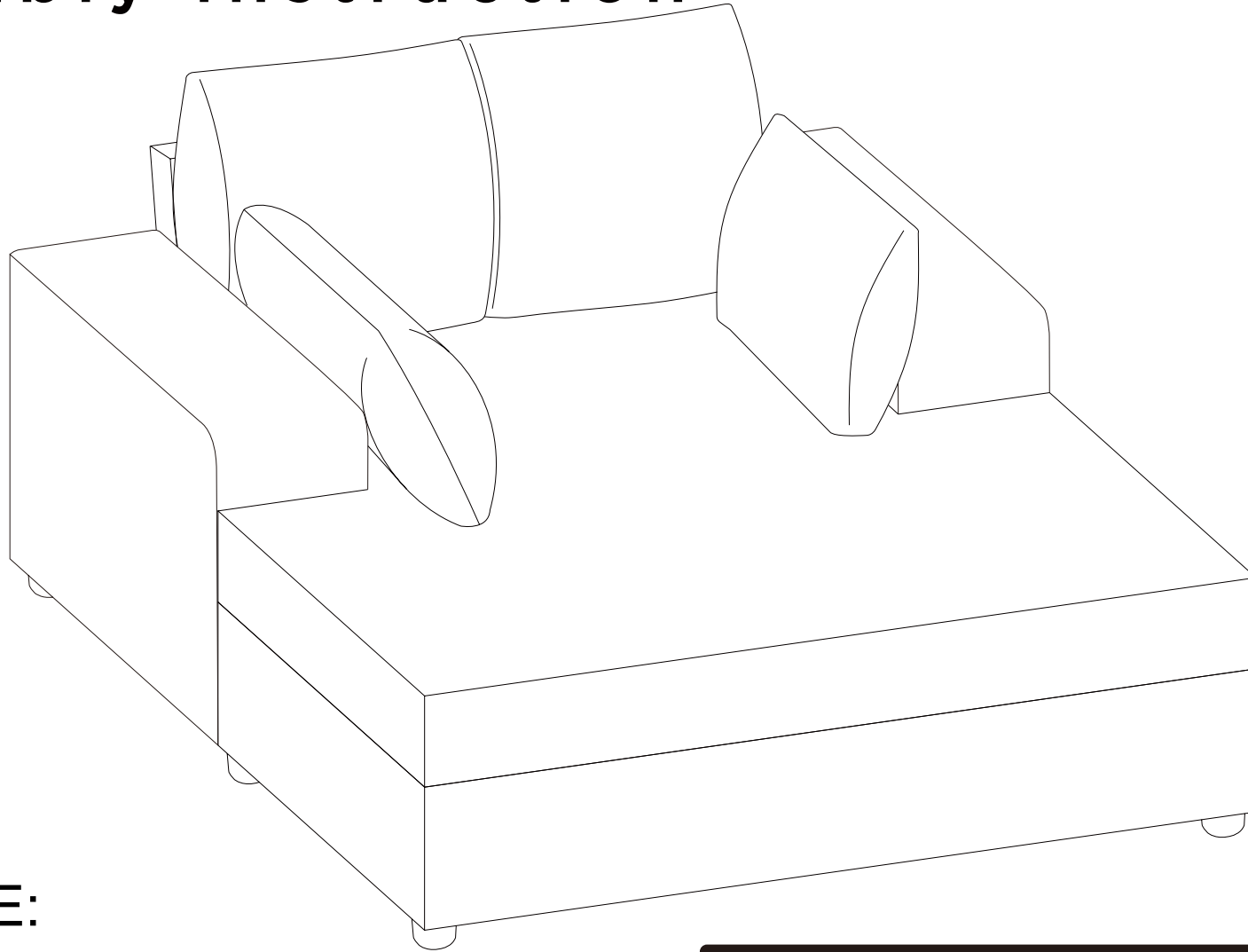

NOTE:

Delivered with TWO PACKAGES with TWO TRACKINGS, may NOT be delivered at the same time.

Any question please feel free to contact us:
support@merluxyhome.com TEL:901-347-2181
We will be of further assistance within 24 hours.



Safety and Care Advice

Important – Please read these instructions fully before starting assembly

Thanks for your purchase. Before assembling, please follow the instructions to check if all the spare parts and screws are intact.

- Considering the size and weight of the sofa, we recommend two adults to assemble the sofa, on a carpeted or padded area, in the room that it is intended for. Approximate assembly time: 30 minutes.
- Keep all components and packaging out of reach of children or animals to avoid the risk of choking or suffocation.
- Please do not throw away any of the packaging or the instruction until you have checked all the components and hardware and the furniture is fully assembled. Please ensure that the packaging is disposed in a safe and environmentally friendly way.
- Please do not take off the cover, and do not wash.

Your cushions come vacuum packed and sealed for shipping. To restore the cushion's original shape, follow the steps below.

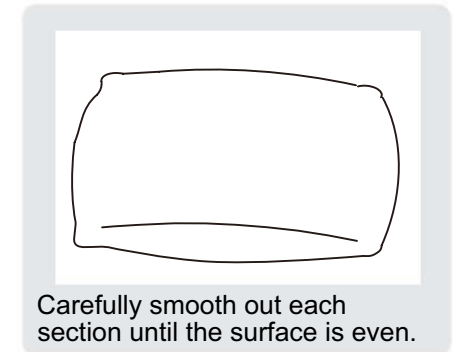
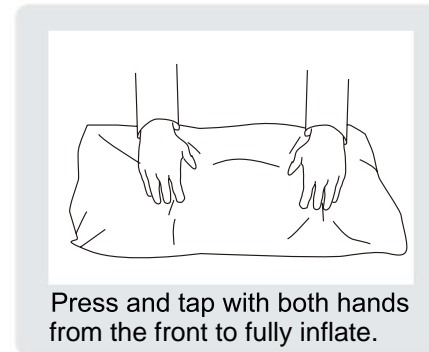
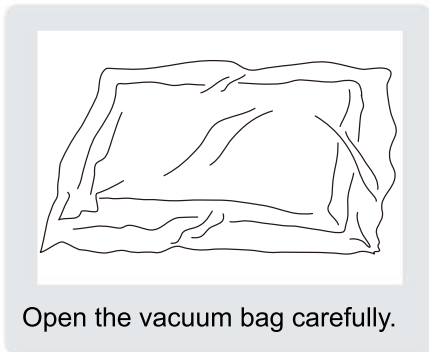

Seller's Notice:



Our product is packed in separate boxes as shown below, and they might be shipped in different batches. Please wait until you received all the boxes then start the assembly.

Noted: Assembly instruction is only provided in Box 1.

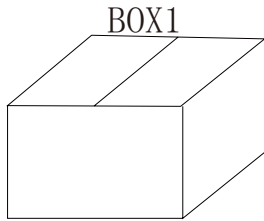
The following is the list of components contained in each box.



Main structure accessories



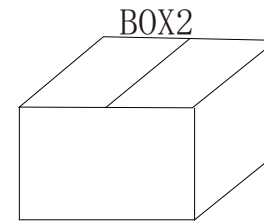

A		Back Frame	x1
D		Cushion	x1
F		Ottoman	x1

Structure accessories

a		Sofa leg	x8
b		Washer	x8

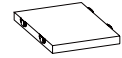

Main structure accessories

B		Backrest	x2
C		Pillow	x2
E		Seat Frame	x1
L		Armrest (L)	x1
R		Armrest (R)	x1

SOFA

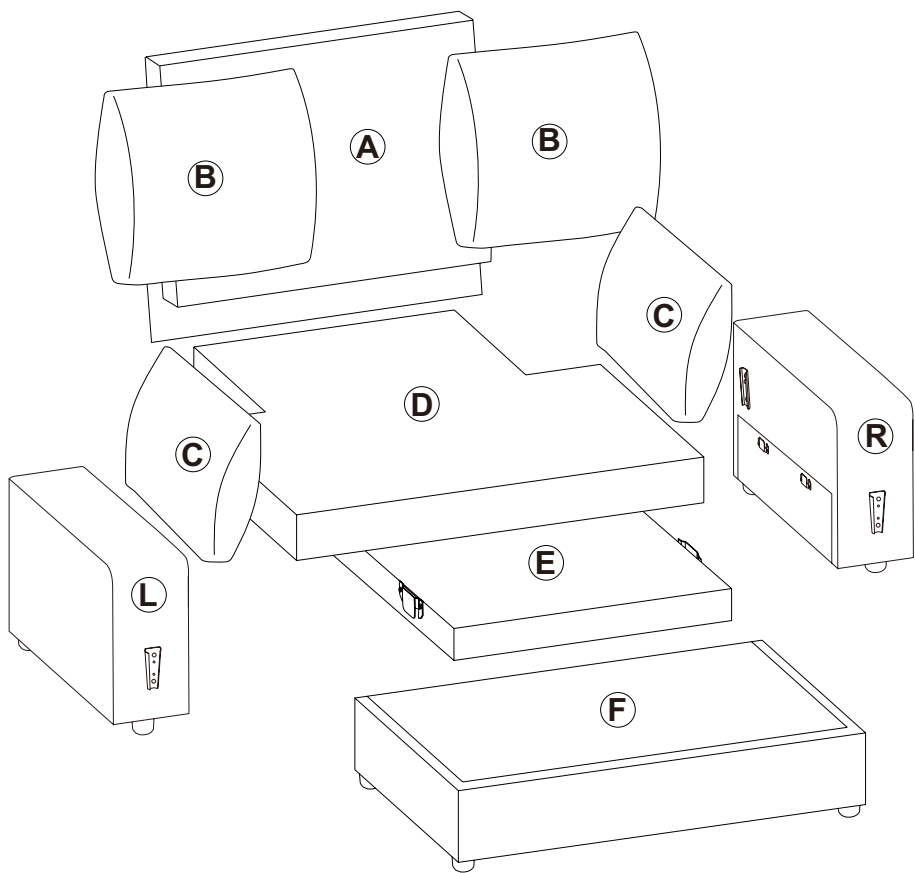

Hardware parts

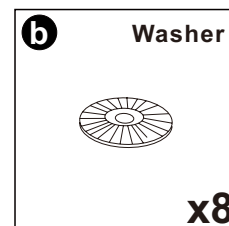
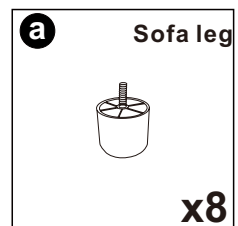

Main structure accessories

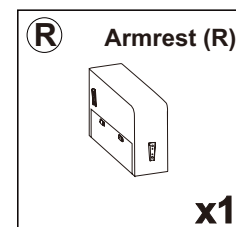
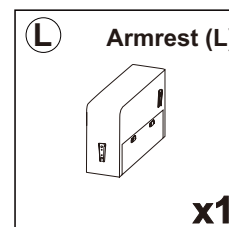
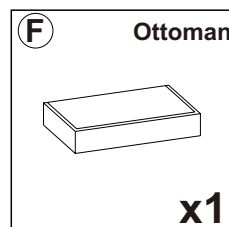
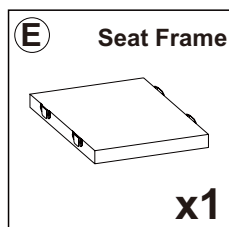
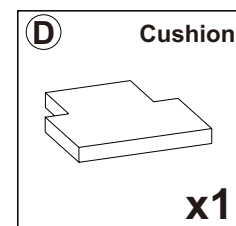
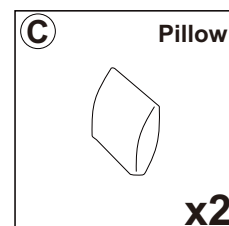
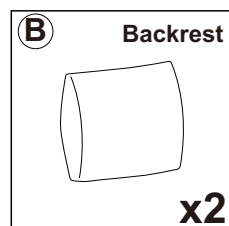
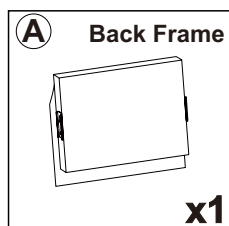

STEP 1

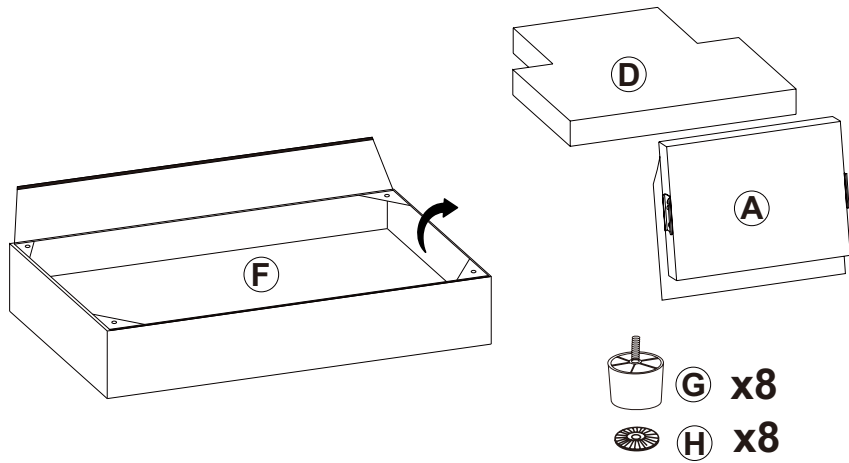

Take out of A、D、G and H from the bottom of F.

STEP 2

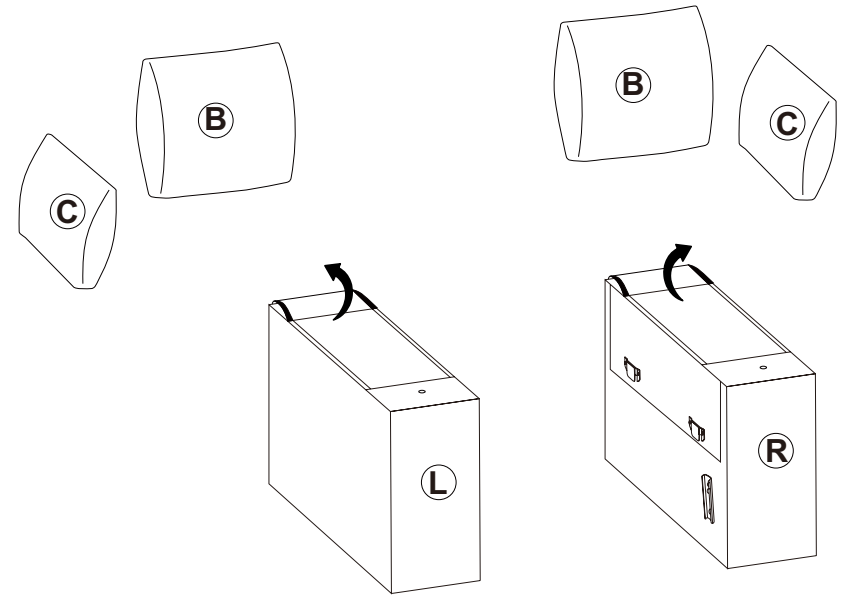

Take out of B and C from the bottom of L and R.

STEP 3

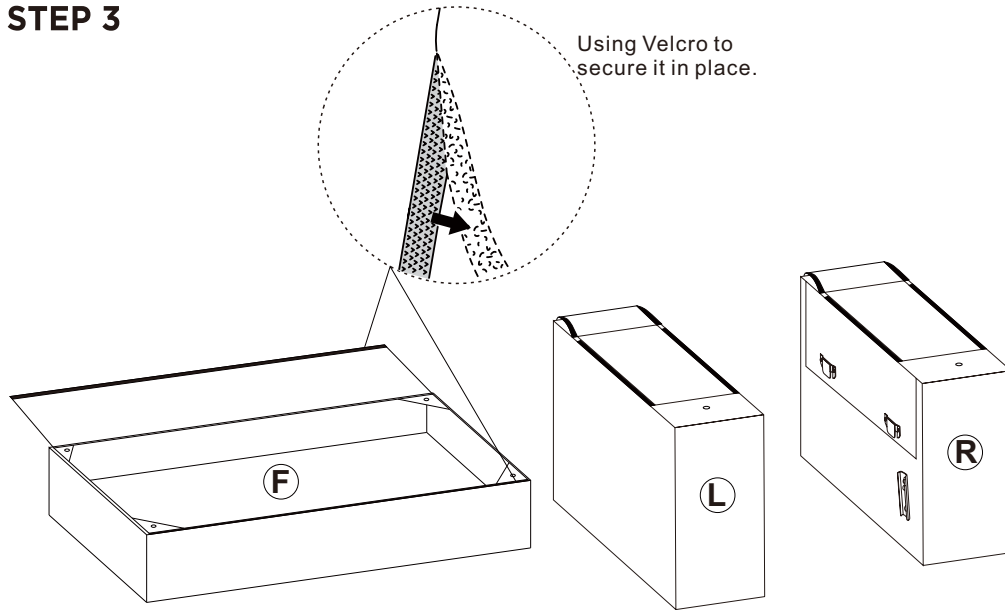

Using Velcro to secure it in place.

STEP 4

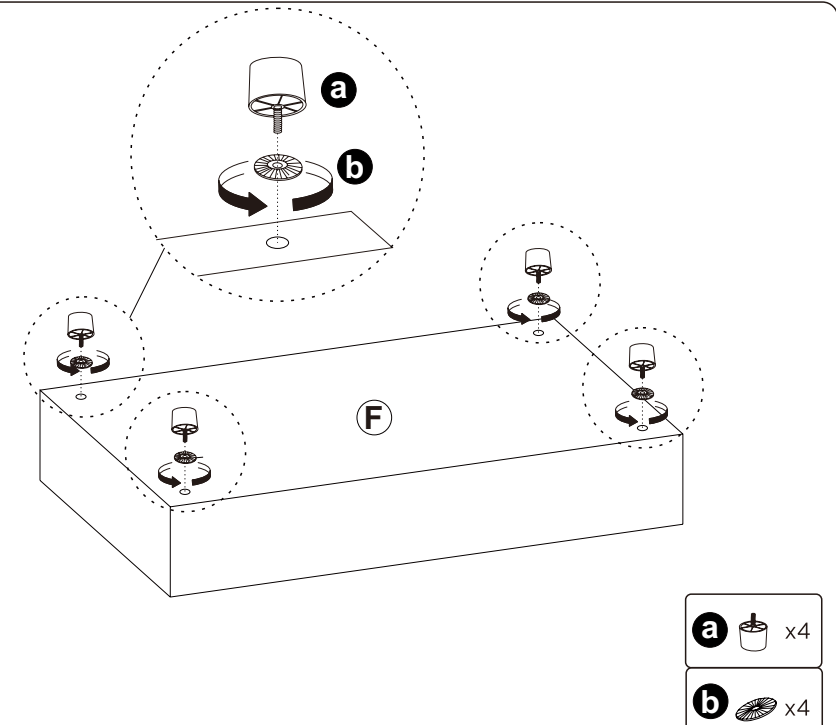



a  x4

b  x4

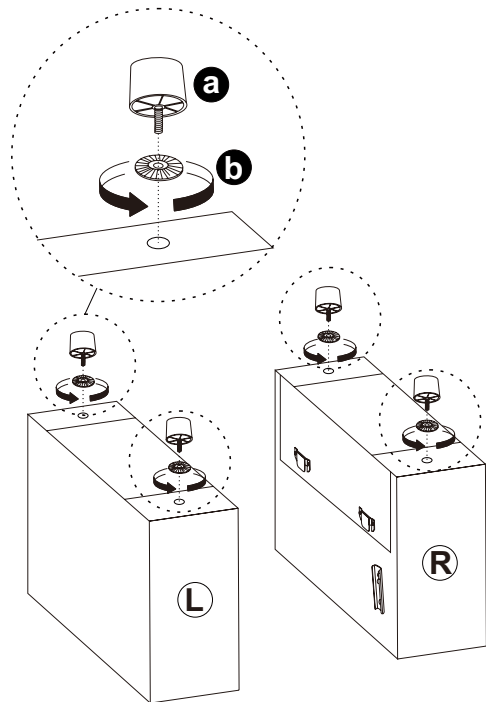
STEP 5



- a**  x4
- b**  x4

STEP 6

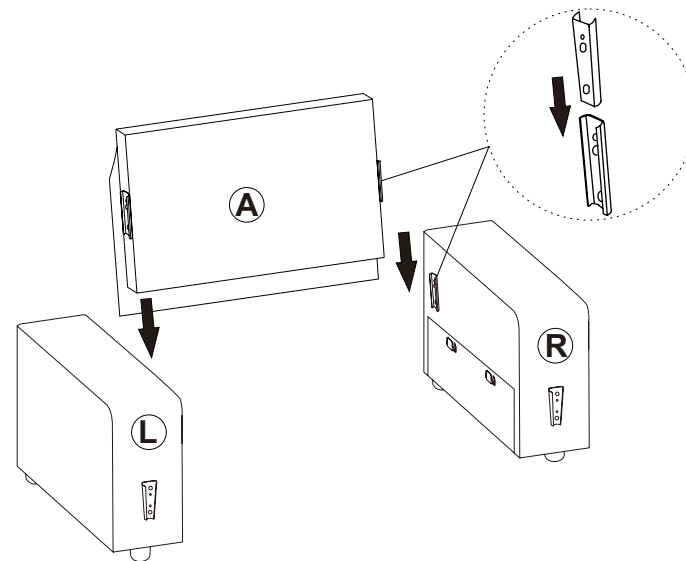

STEP 7

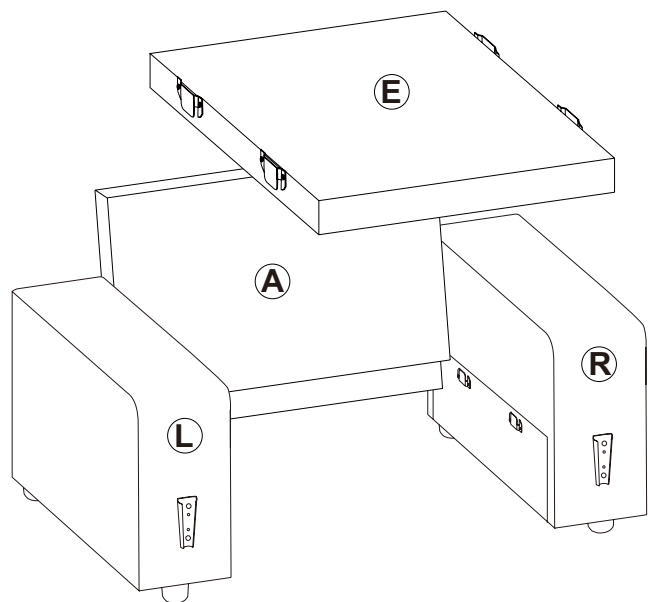

STEP 8

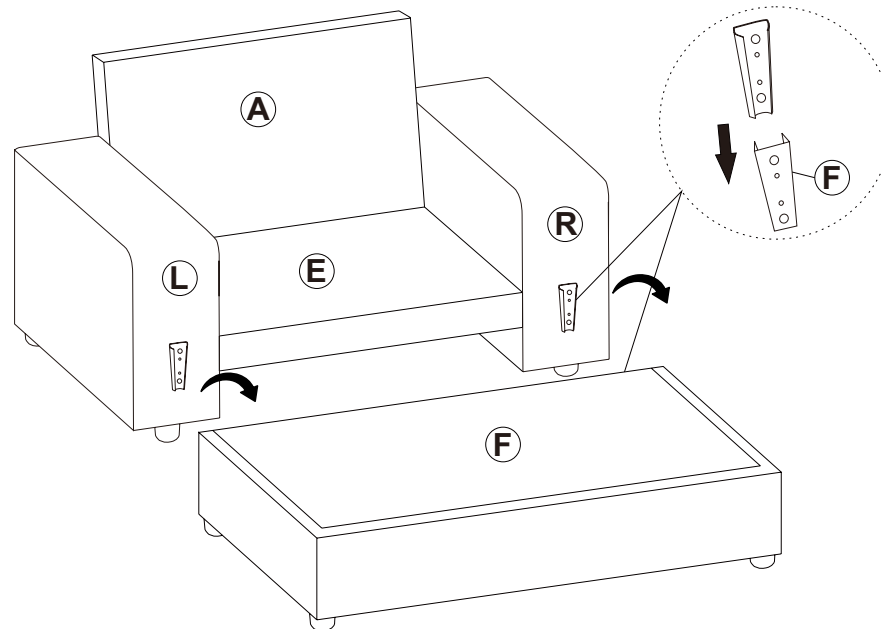

STEP 9

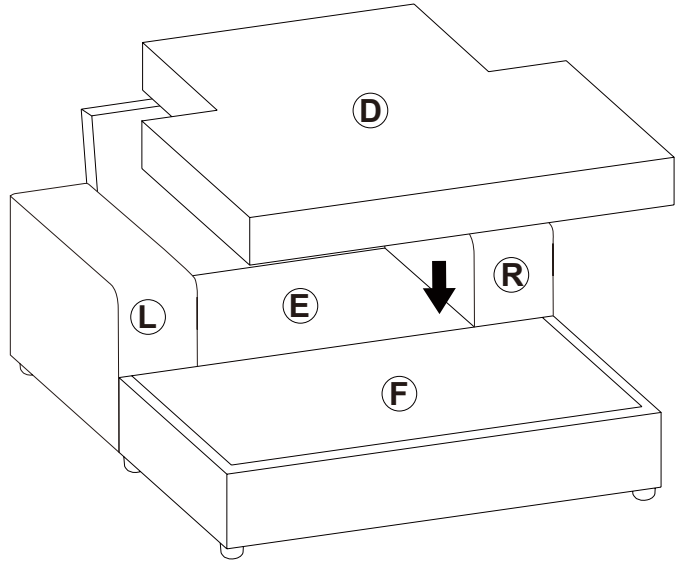

STEP 10

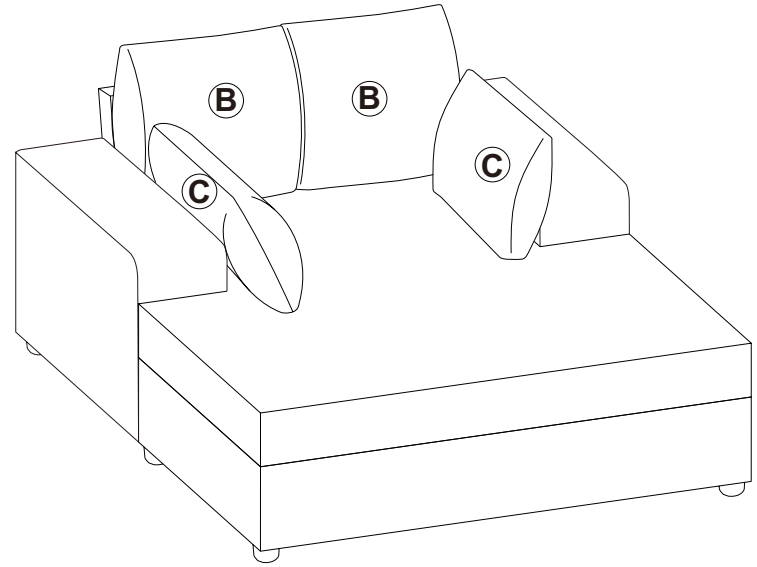

STEP 11

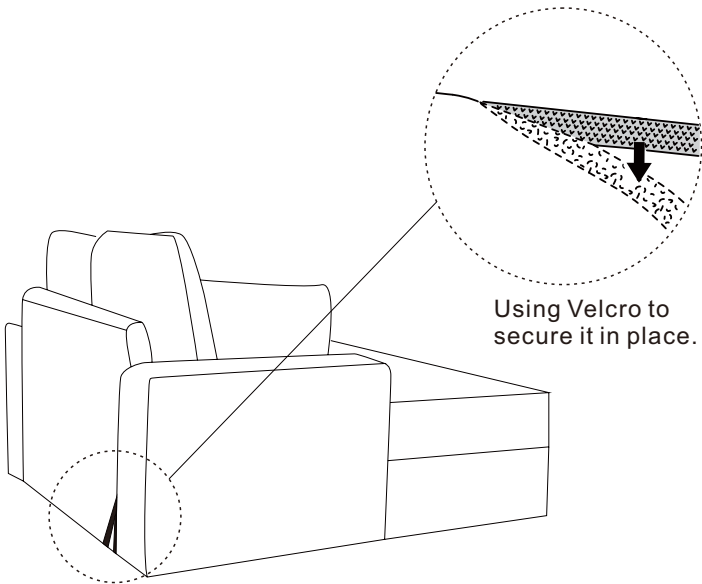

STEP 12

