

Acrylic Button Bed Frame With LED Light Strip(Y175-Q)

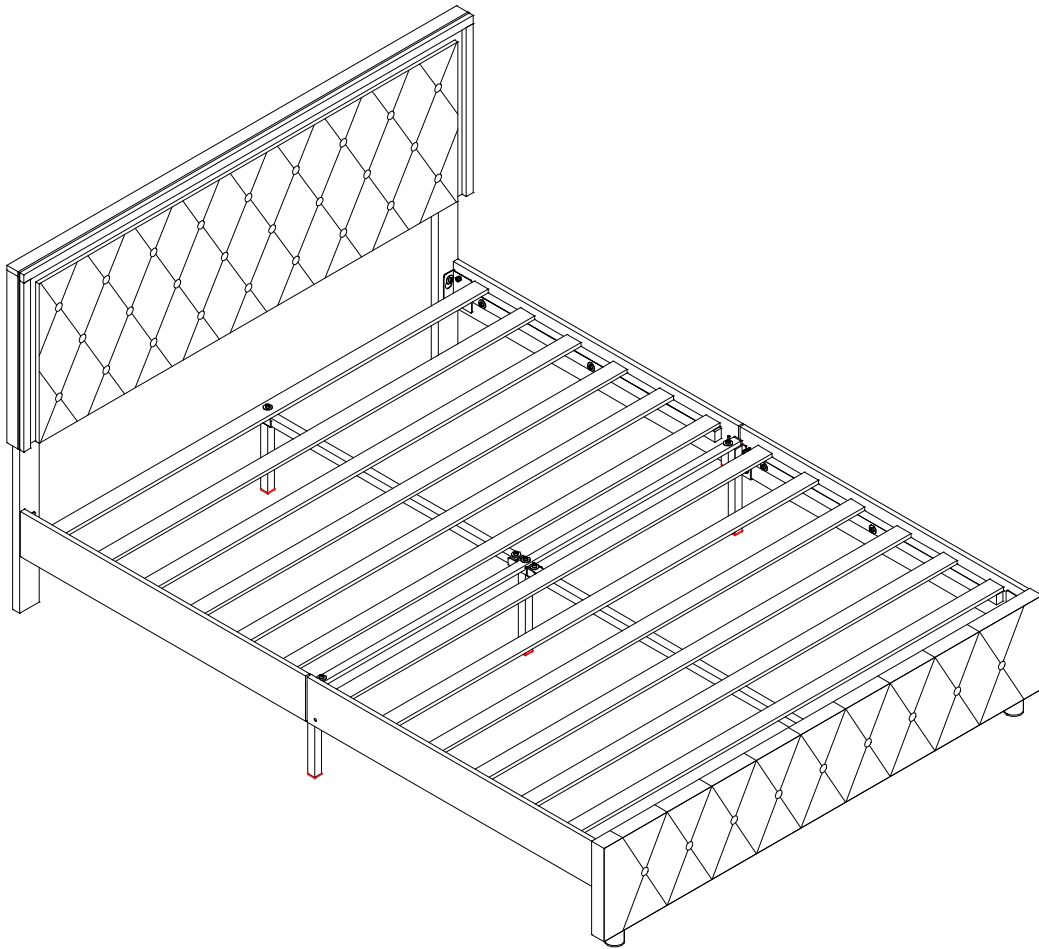

Friendly Customer Service

Satisfaction Guarantees: Any problems with assembly, quality, or return, please feel free to contact us directly.

Contact us

Phone: +1 (901) 347-2181 (US) Mon-Fri 9am - 5pm (PST)

E-Mail: support@jocisland.com (Get efficient answer within 12 hours)



Please follow the instruction manuals and use a pad to protect the product during your assembly.

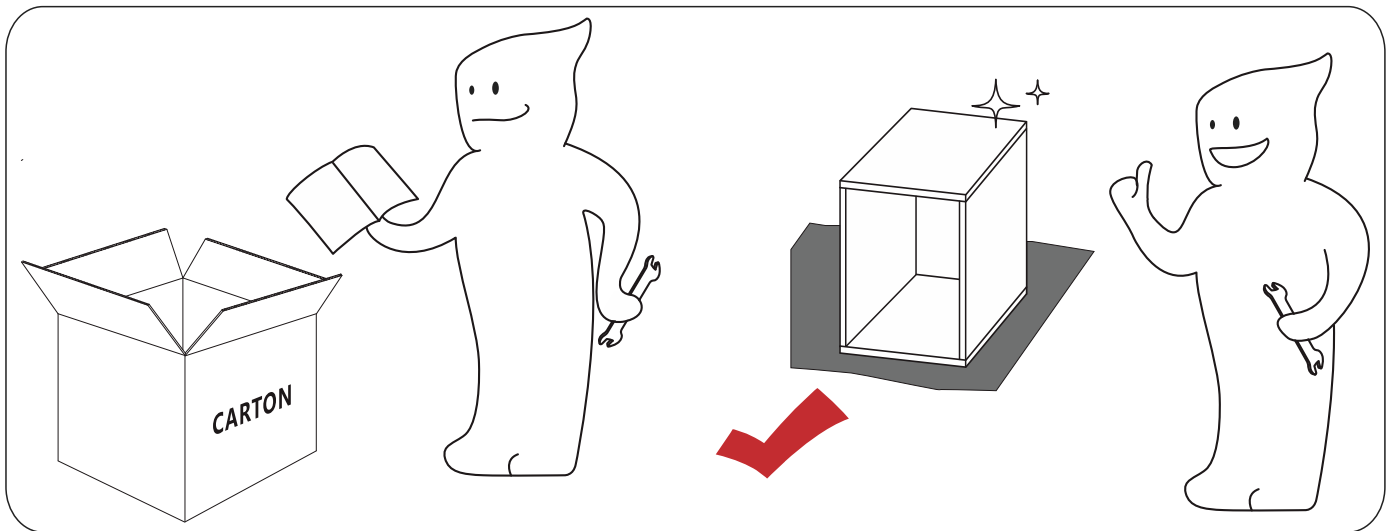
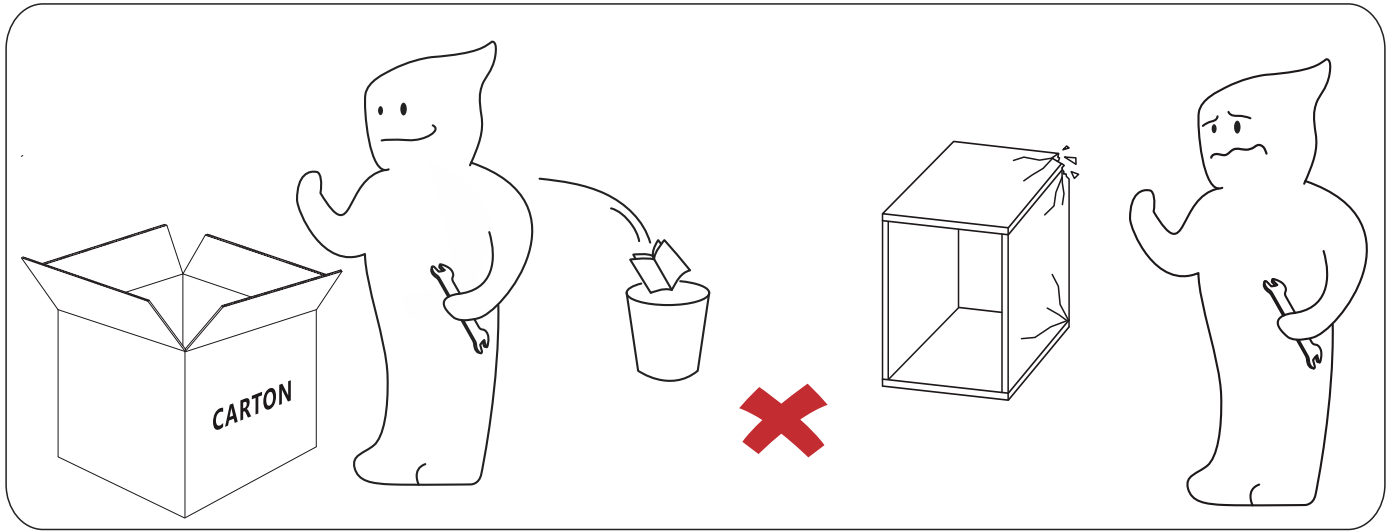



Note:

1. Should be assembled on flat ground to keep balance.
2. Before completing the installation, do not tighten the screws.

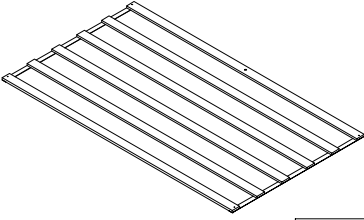
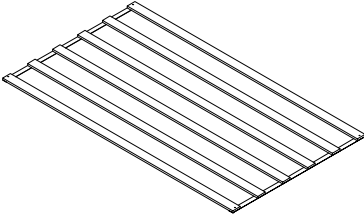
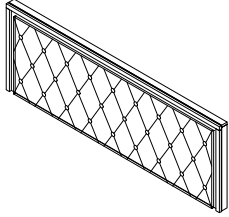

For easier and better assembly, **2** or more adults are required.

BED FRAME PARTS LIST

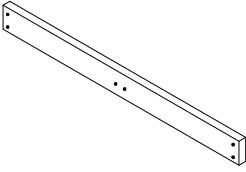
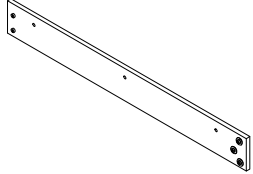
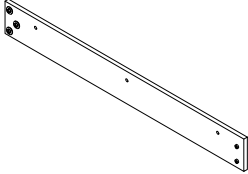
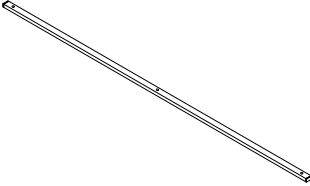
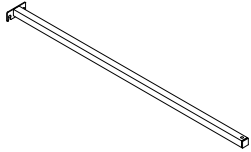
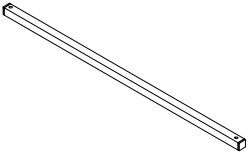
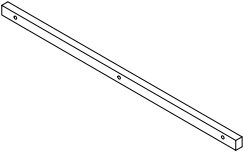
<p>A Front slat</p>  <div style="text-align: right; border: 1px solid black; padding: 2px; width: fit-content; margin-left: auto;">1pc</div>	<p>B Back slat</p>  <div style="text-align: right; border: 1px solid black; padding: 2px; width: fit-content; margin-left: auto;">1pc</div>	<p>C Headboard</p>  <div style="text-align: right; border: 1px solid black; padding: 2px; width: fit-content; margin-left: auto;">1pc</div>
<p>D Headboard side leg</p>  <div style="text-align: right; border: 1px solid black; padding: 2px; width: fit-content; margin-left: auto;">2pcs</div>	<p>E Footboard</p>  <div style="text-align: right; border: 1px solid black; padding: 2px; width: fit-content; margin-left: auto;">1pc</div>	<p>F1 The left front siderail</p>  <div style="text-align: right; border: 1px solid black; padding: 2px; width: fit-content; margin-left: auto;">2pcs</div>
<p>F2 The right front siderail</p>  <div style="text-align: right; border: 1px solid black; padding: 2px; width: fit-content; margin-left: auto;">2pcs</div>	<p>G The brace</p>  <div style="text-align: right; border: 1px solid black; padding: 2px; width: fit-content; margin-left: auto;">1pc</div>	<p>H Back middle cross beam</p>  <div style="text-align: right; border: 1px solid black; padding: 2px; width: fit-content; margin-left: auto;">1pc</div>
<p>I Front middle cross beam</p>  <div style="text-align: right; border: 1px solid black; padding: 2px; width: fit-content; margin-left: auto;">1pc</div>	<p>Z Support wood</p>  <div style="text-align: right; border: 1px solid black; padding: 2px; width: fit-content; margin-left: auto;">4pcs</div>	

FITTING PART LIST

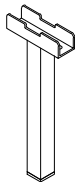
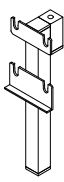
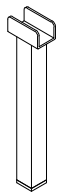
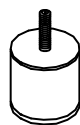
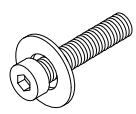
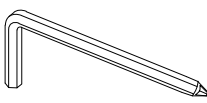
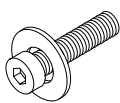
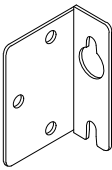
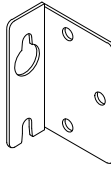
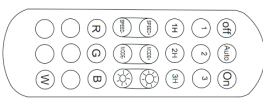
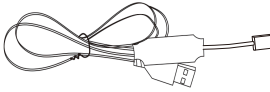
<p>J Middle leg</p>  <div style="text-align: right; border: 1px solid black; padding: 2px; width: fit-content; margin-left: auto;">1pc</div>	<p>K Side foot</p>  <div style="text-align: right; border: 1px solid black; padding: 2px; width: fit-content; margin-left: auto;">2pcs</div>	<p>L Front leg</p>  <div style="text-align: right; border: 1px solid black; padding: 2px; width: fit-content; margin-left: auto;">1pc</div>
<p>M Bed leg</p>  <div style="text-align: right; border: 1px solid black; padding: 2px; width: fit-content; margin-left: auto;">2pcs</div>	<p>N Innerscrew</p>  <p style="margin-top: 5px;">M8X45mm</p> <div style="text-align: right; border: 1px solid black; padding: 2px; width: fit-content; margin-left: auto;">10+1pcs</div>	<p>P Inner allen wrench</p>  <div style="text-align: right; border: 1px solid black; padding: 2px; width: fit-content; margin-left: auto;">1pc</div>
<p>Y Innerscrew</p>  <p style="margin-top: 5px;">M8X38mm</p> <div style="text-align: right; border: 1px solid black; padding: 2px; width: fit-content; margin-left: auto;">12pcs</div>	<p>W Left bracket</p>  <div style="text-align: right; border: 1px solid black; padding: 2px; width: fit-content; margin-left: auto;">2pcs</div>	<p>X Right bracket</p>  <div style="text-align: right; border: 1px solid black; padding: 2px; width: fit-content; margin-left: auto;">2pcs</div>
<p>W1 Controller</p>  <div style="text-align: right; border: 1px solid black; padding: 2px; width: fit-content; margin-left: auto;">1pc</div>	<p>X1 Receiver</p>  <div style="text-align: right; border: 1px solid black; padding: 2px; width: fit-content; margin-left: auto;">1pc</div>	Empty cell

STEP 1

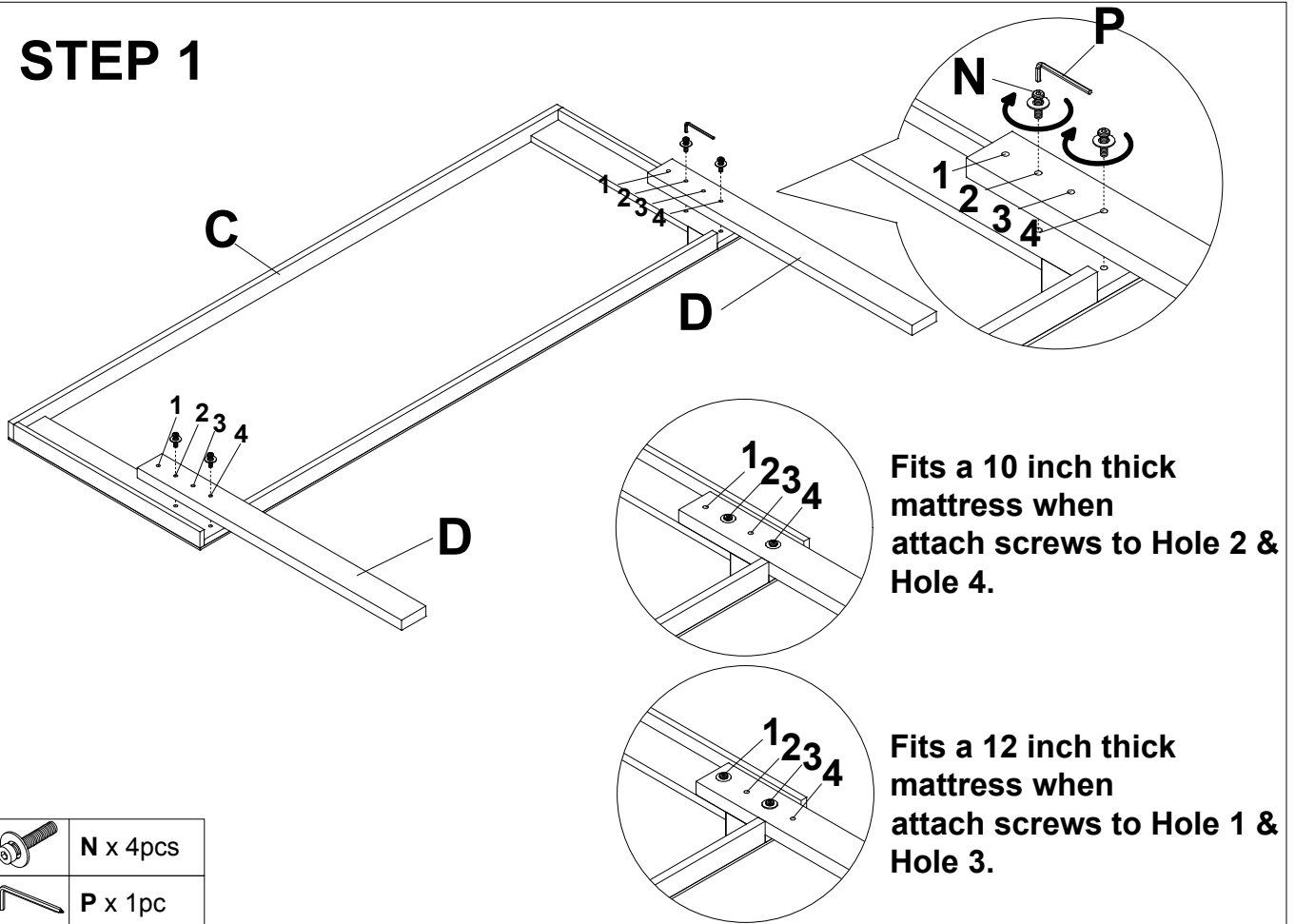



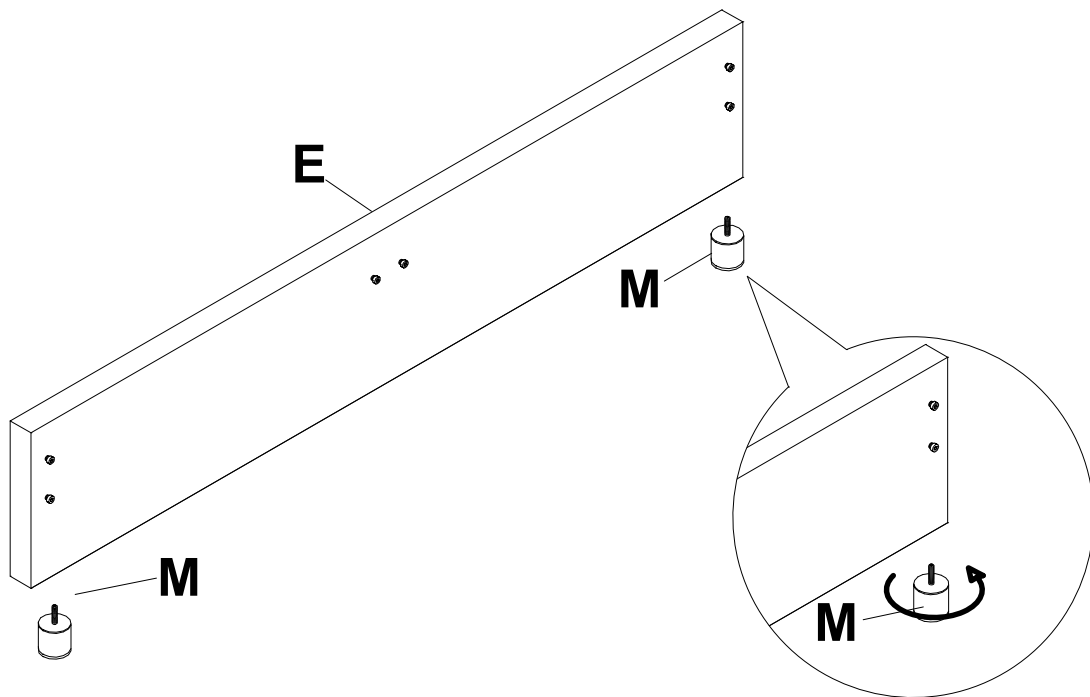

STEP 2

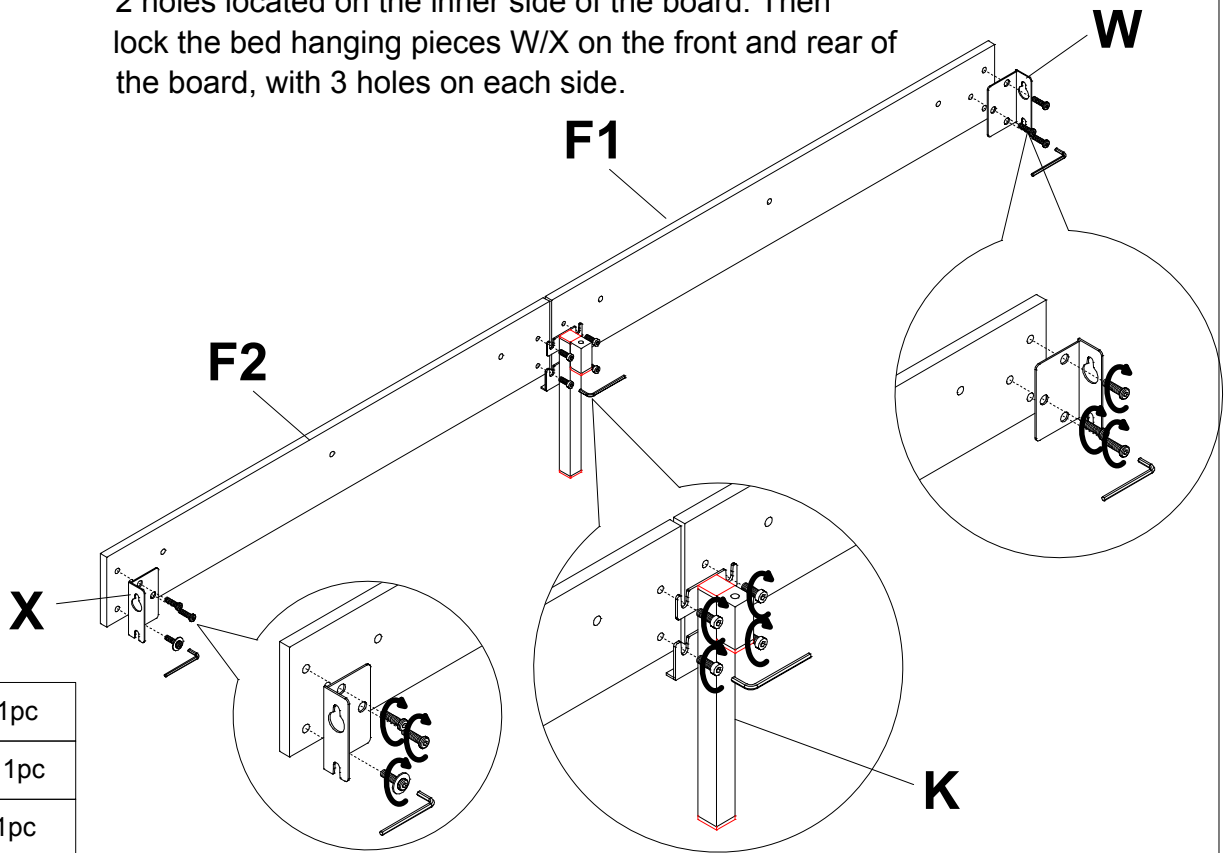

STEP 3

Take out parts F1 and F2, and lock the iron frame foot K in the middle according to the figure. Note that there are 2 holes located on the inner side of the board. Then lock the bed hanging pieces W/X on the front and rear of the board, with 3 holes on each side.





	X x 1pc
	W x 1pc
	P x 1pc

STEP 4

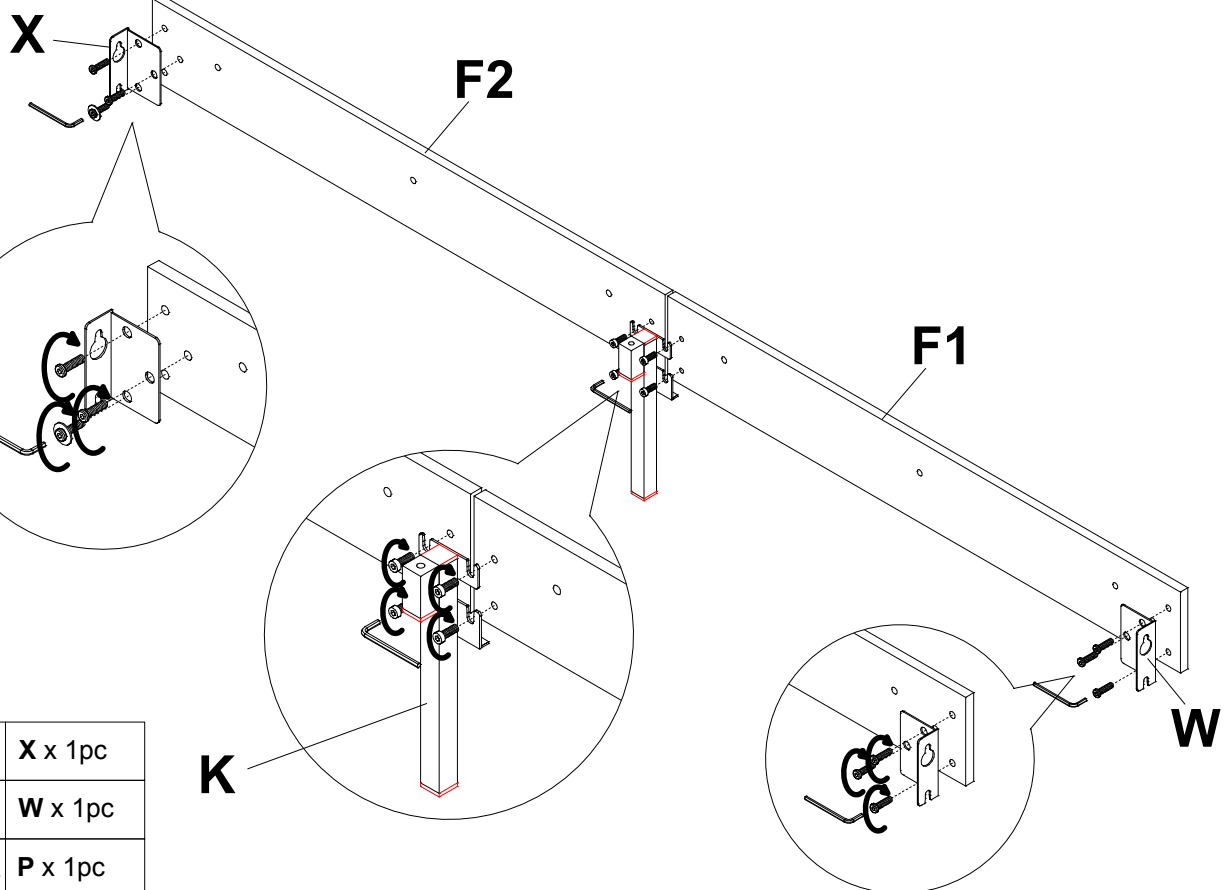
Same as Step 3



	X x 1pc
	W x 1pc
	P x 1pc

STEP 5

Noted that the middle cross beam, the direction of the red arrow is aiming front.

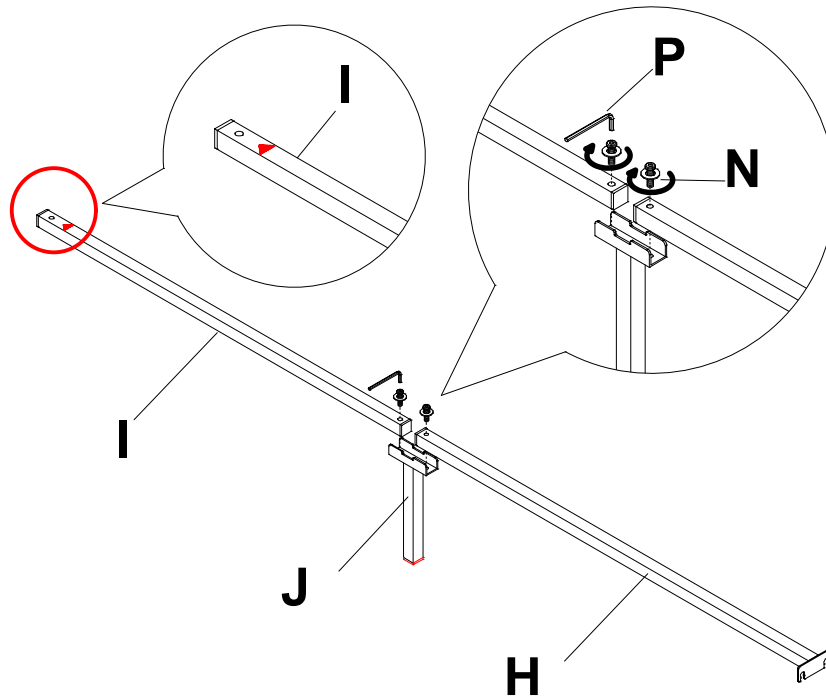

N x 2pcs



P x 1pc

STEP 6

Loosen screws on the side leg of the headboard and both sides of the footboard, then, hang the bracket on and tighten the innerscrews

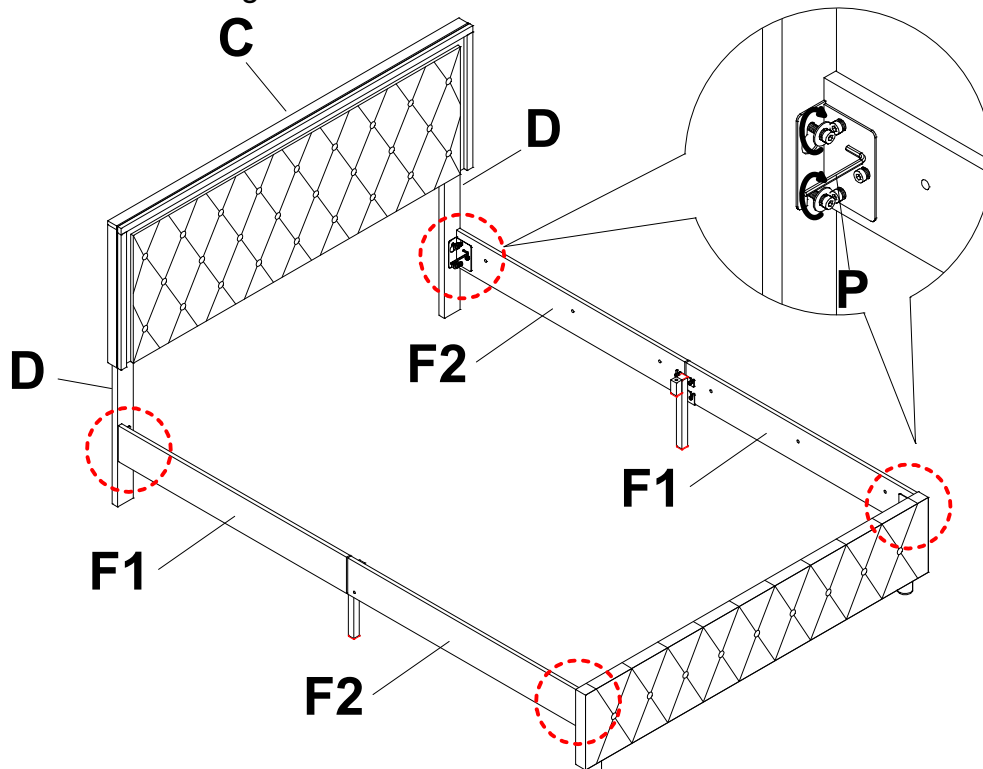

P x 1pc

STEP 7

Loosen screws on the middle of the footboard, then, hang the bracket on the footboard and tighten the innerscrews.

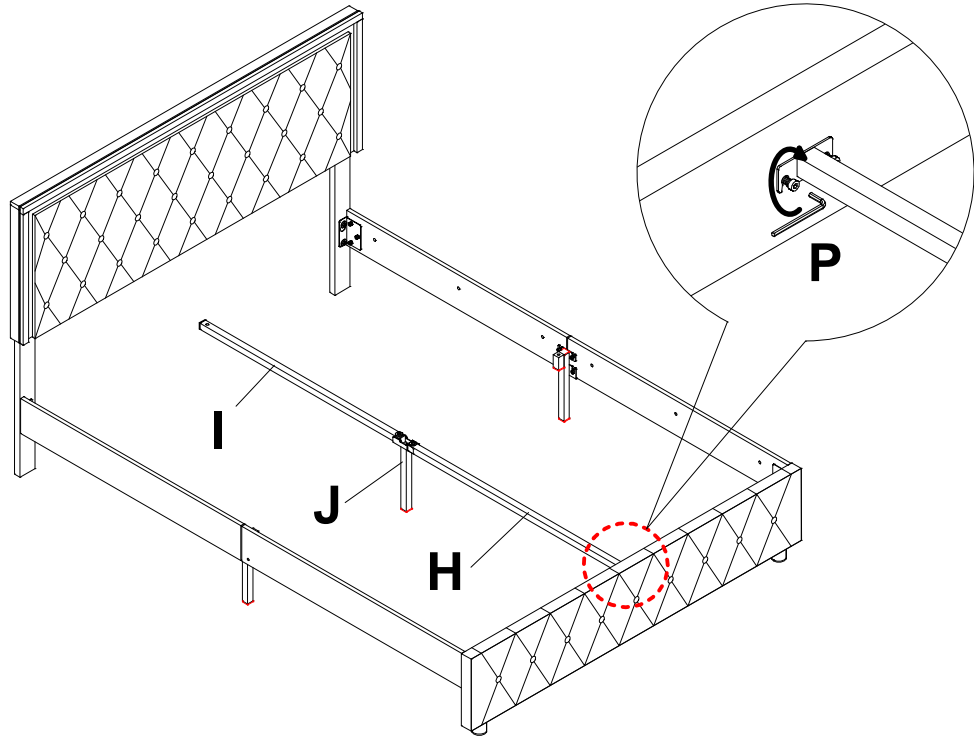

 P x 1pc

STEP 8

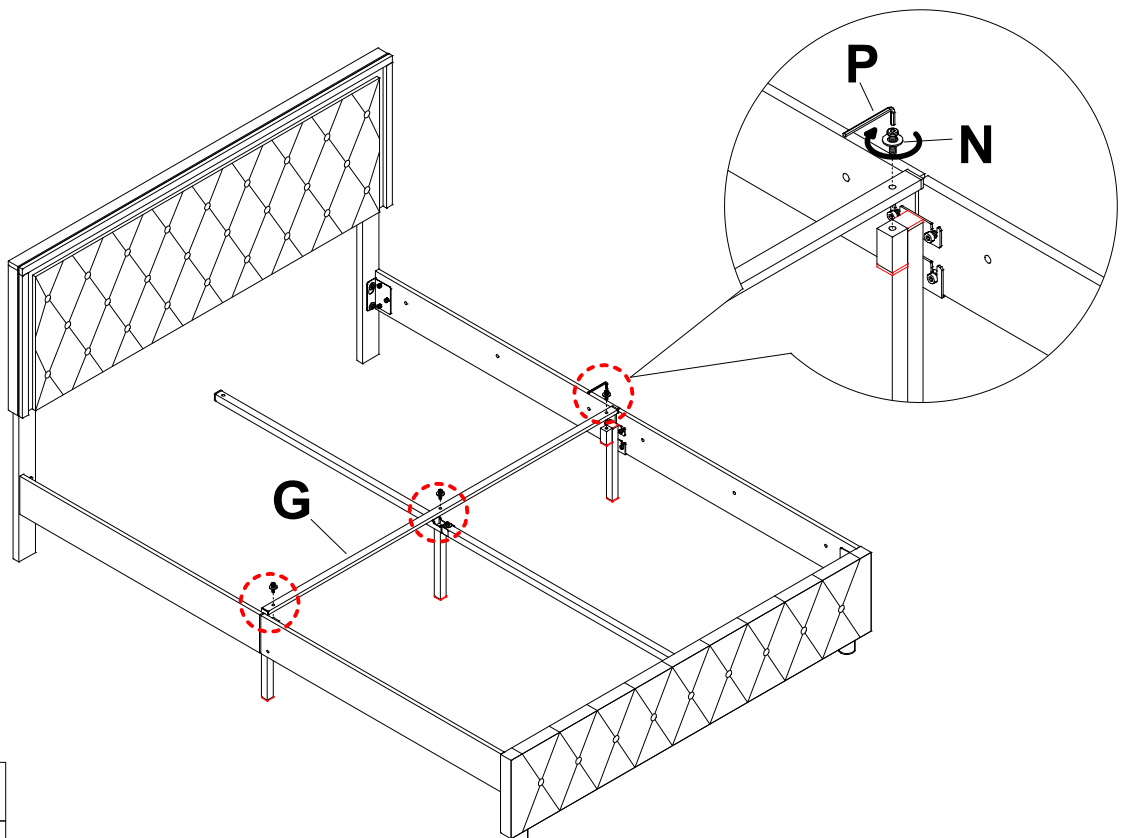



 N x 3pcs

 P x 1pc

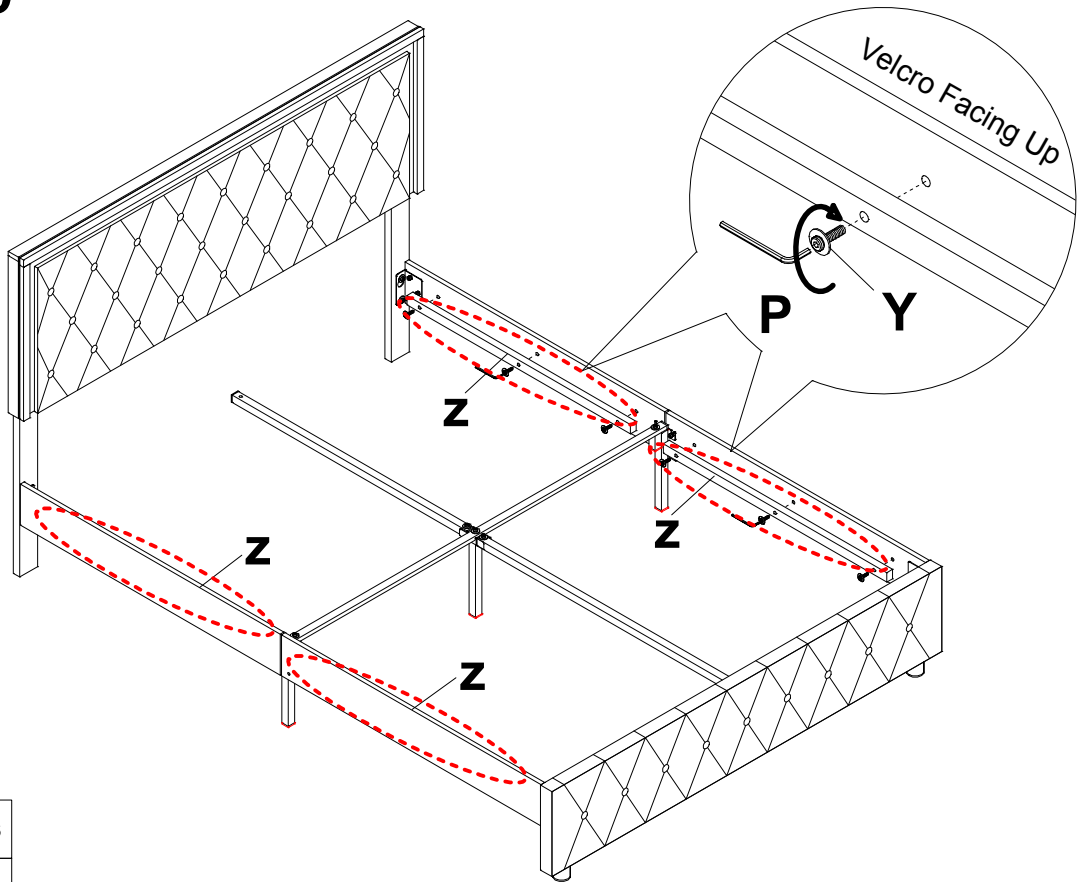

STEP 9

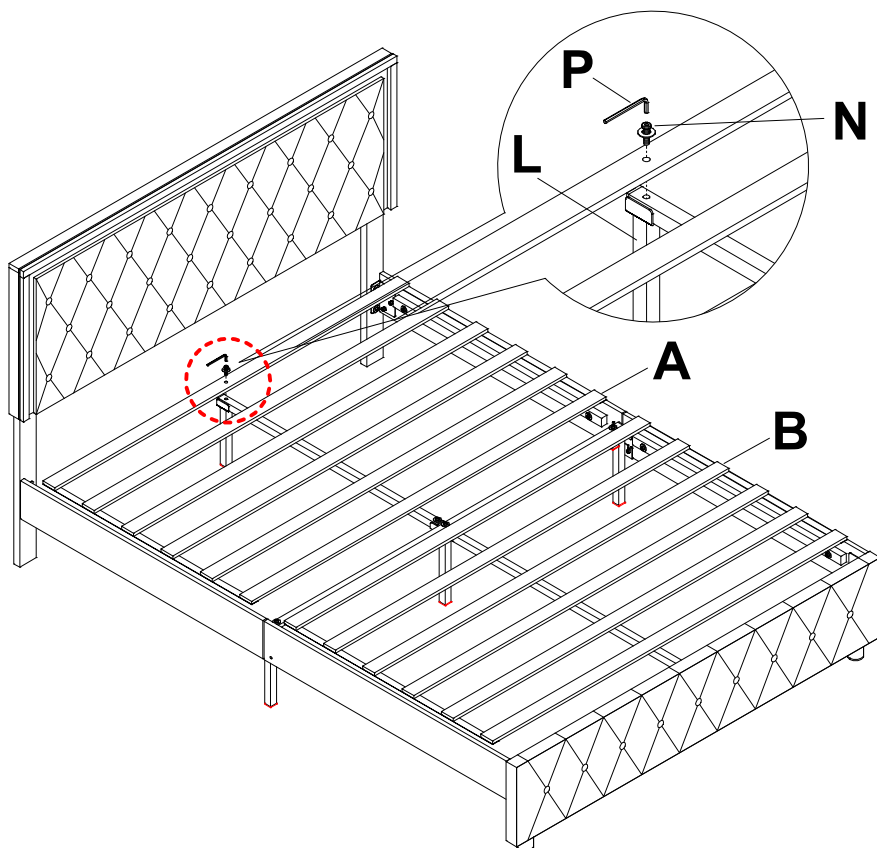

	Y x 12pcs
	P x 1pc

STEP 10



	N x 1pc
	P x 1pc

STEP 11

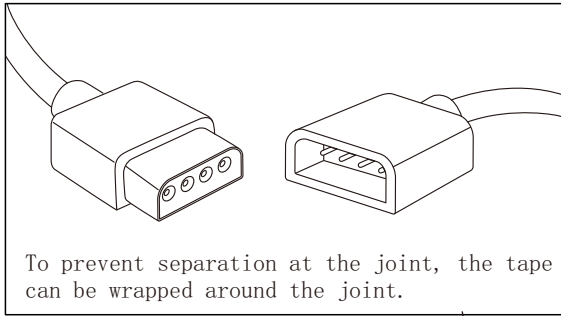

NOTE: The black part of the receiverXX needs to be exposed to air in order to better control the LED light.

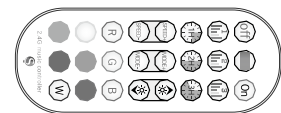
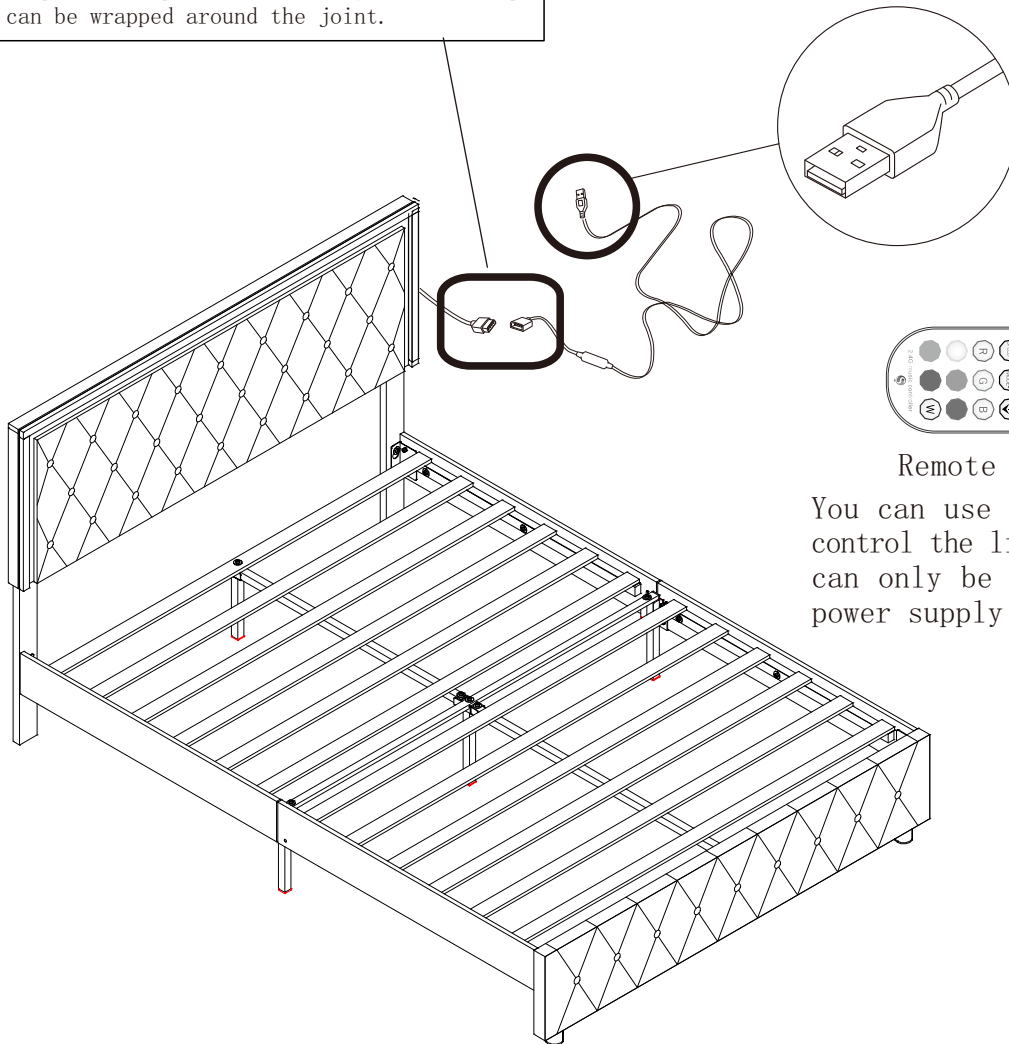

Remote control

You can use the remote to control the light. The LED lamp can only be used after the power supply is connected.

Please scan the QR code on the manual/controller and install the application.

Step1: Please make sure your phone has Bluetooth enabled.

Step2: The LED light will automatically connect to the APP.

