

Bed Frame with Storage Headboard & Charging Station Assembly Instructions

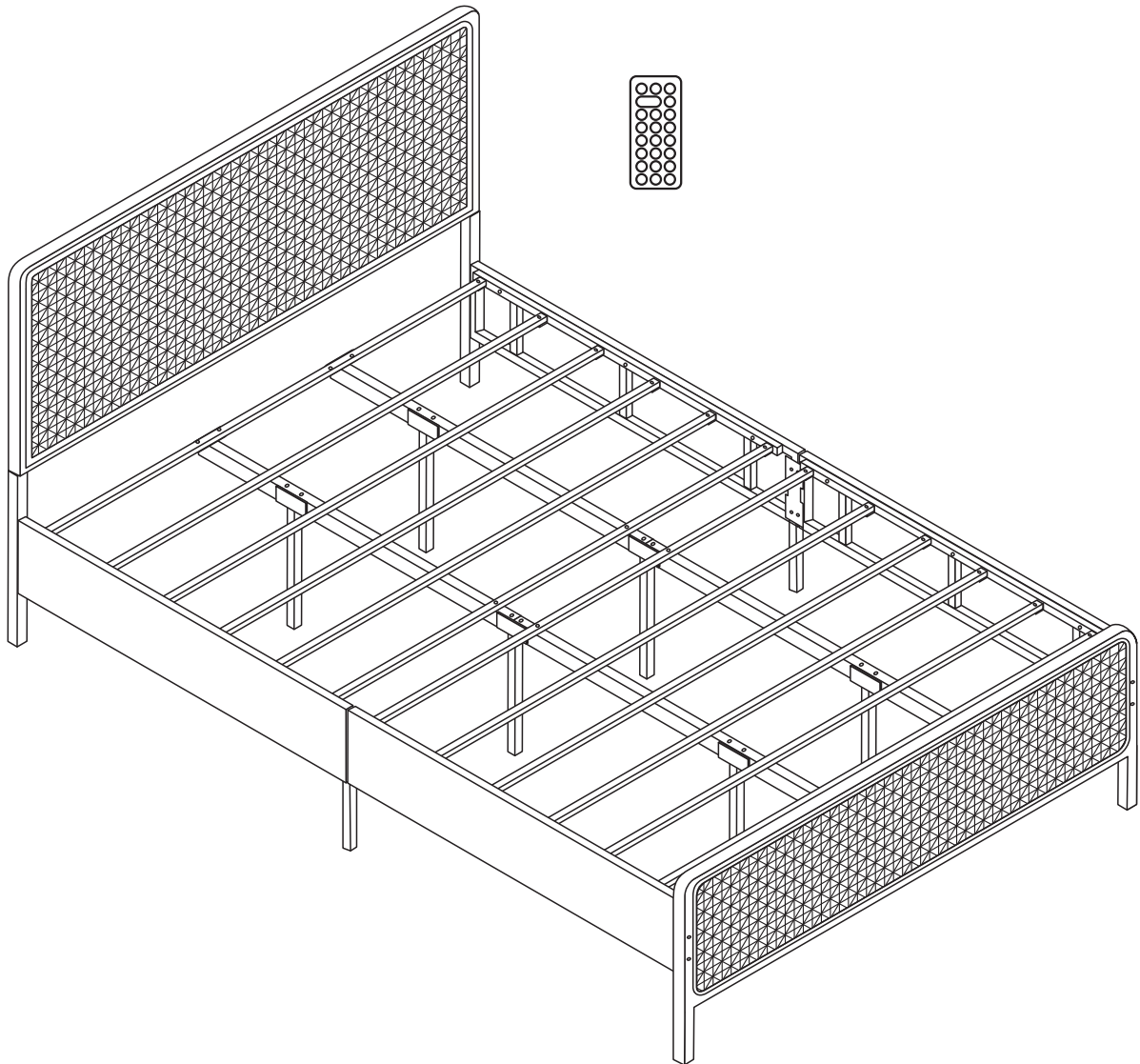

Dear Customers,

Thank you for purchasing our product. Please read this instruction manual carefully after receiving this product. It will help you assemble this product quickly, safely and correctly. You can keep this manual for future reference.

MADE IN CHINA



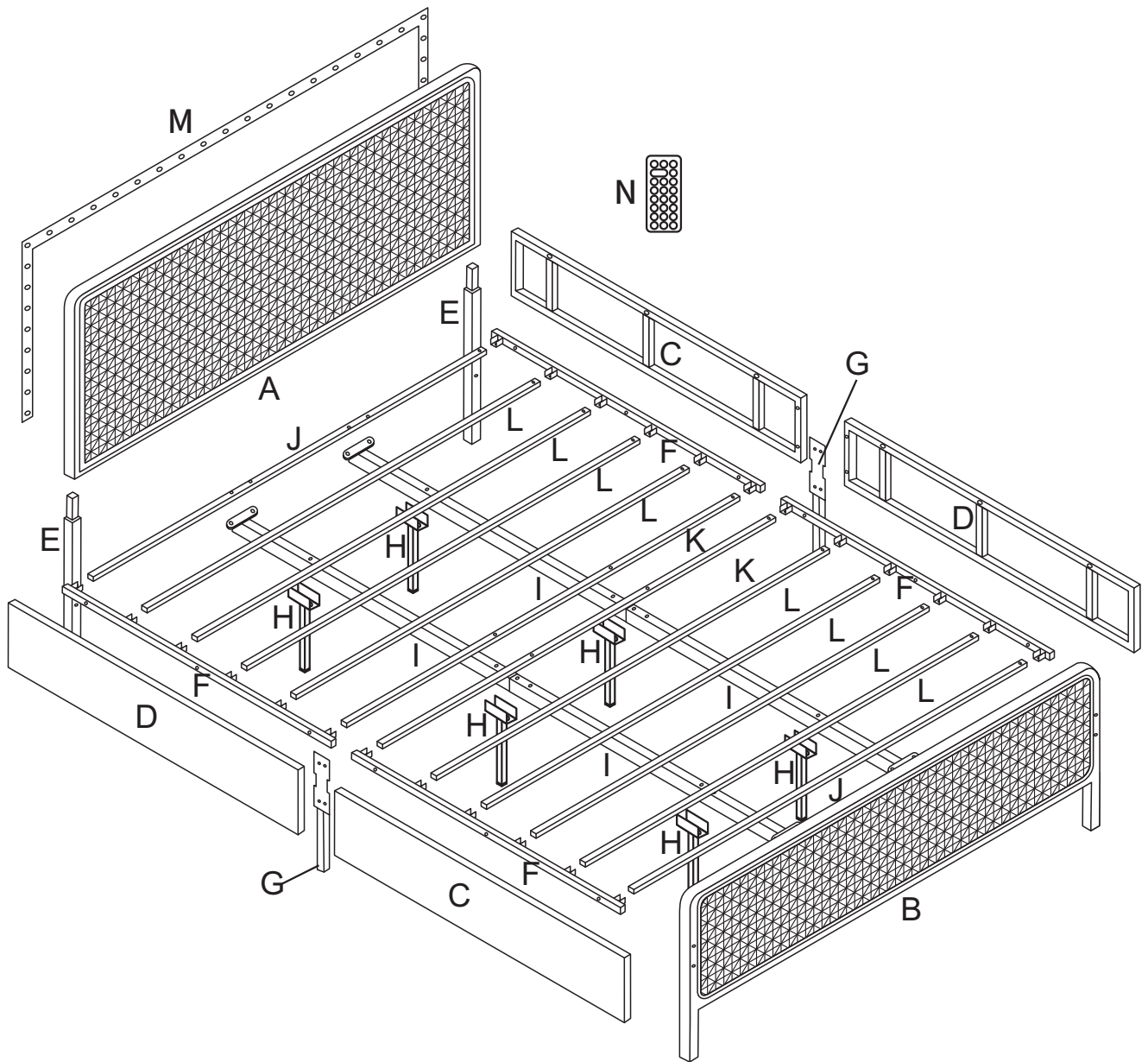







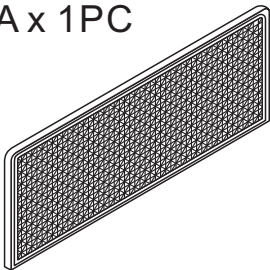
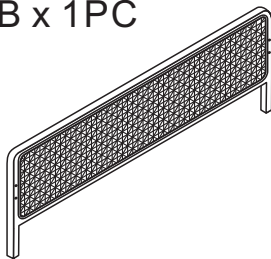
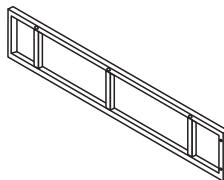
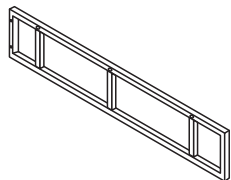

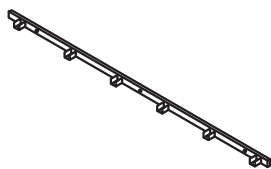

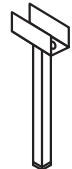
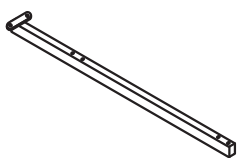
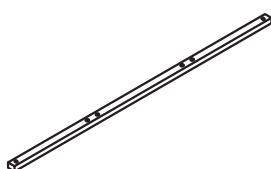
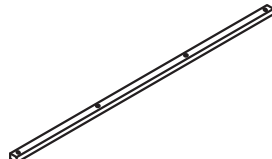
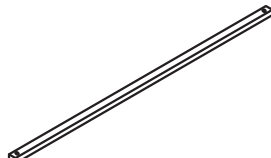
ASSEMBLY INSTRUCTIONS

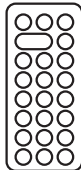

Notice: Do not tighten the screws too tightly at the beginning of the assembly. Wait until all the hole positions and screws are matched, then gently tighten all the screws.

ASSEMBLY INSTRUCTIONS

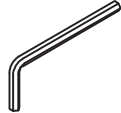
PARTS LIST

A x 1PC 		B x 1PC 		C x 2PCS 		D x 2PCS 			
E x 2PCS 		F x 4PCS 		G x 2PCS 		H x 6PCS 			
I x 4PCS 		J x 2PCS 		K x 2PCS 		L x 8PCS 			
M x 1PC 		N x 1PC 							
1	x8PCS	2	x36PCS	3	x12PCS	4	x24PCS	5	x8PCS
									
M8 x 55mm		M6 x 25mm		M6 x 35mm		M8 x 25mm		M6	
6	x1PC	7	x1PC						
									

ASSEMBLY INSTRUCTIONS

1

Notice: It's back of headboard here

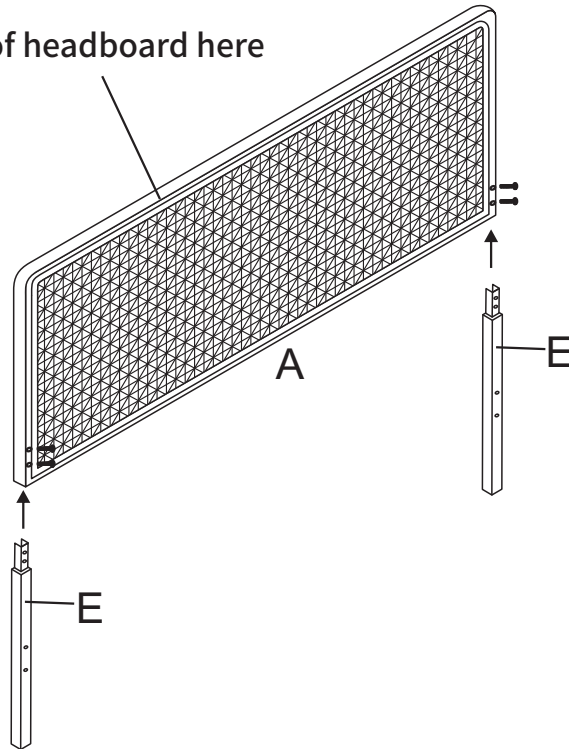

4

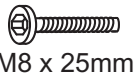

4PCS

M8 x 25mm

2

Notice: It's back of headboard here

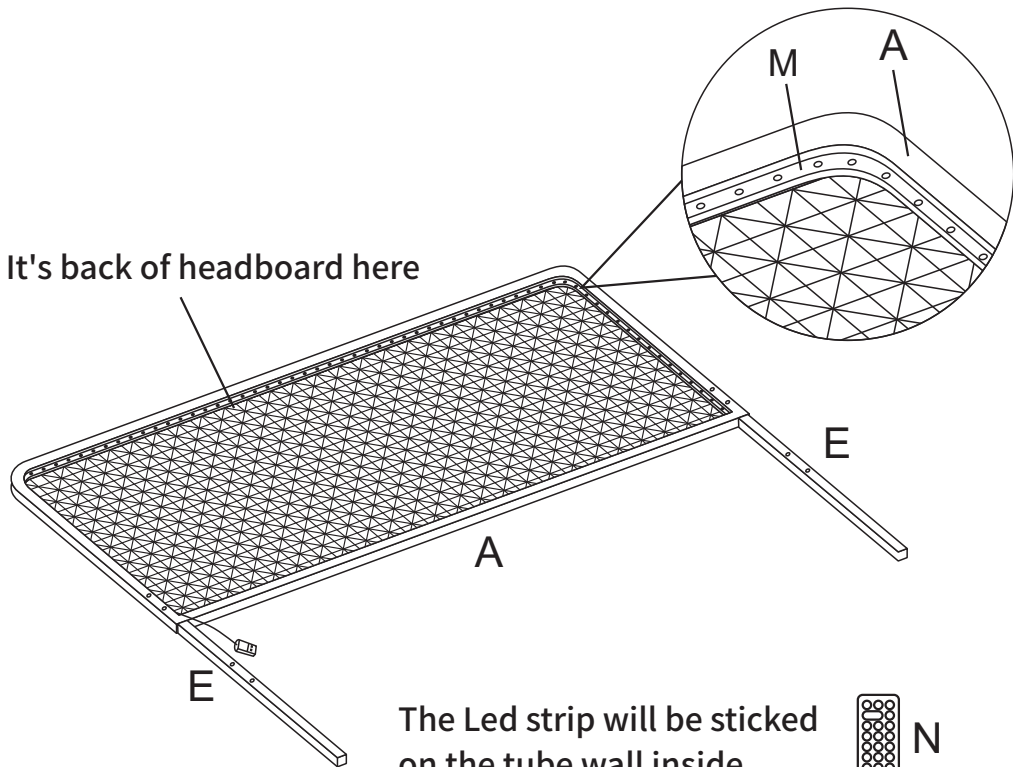

The Led strip will be sticked on the tube wall inside



ASSEMBLY INSTRUCTIONS

3

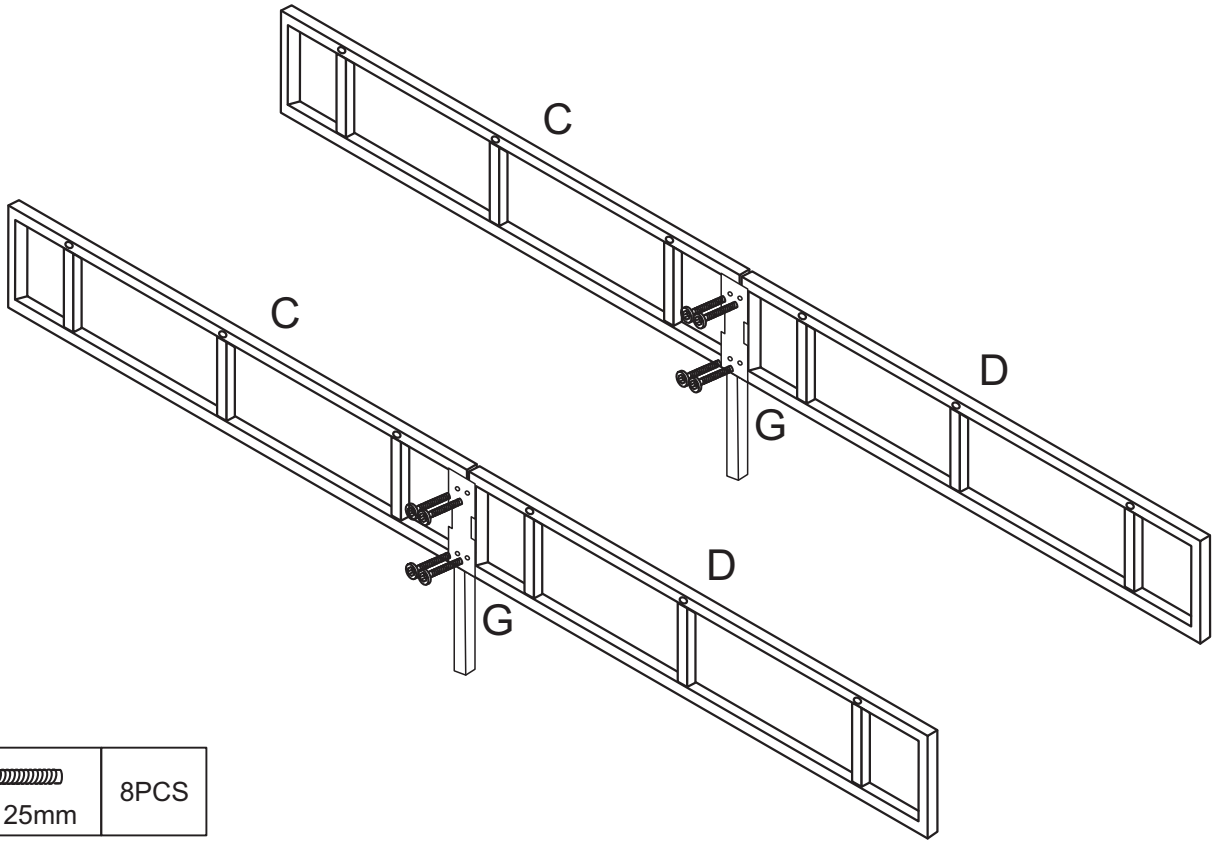

4

 M8 x 25mm

8PCS

4

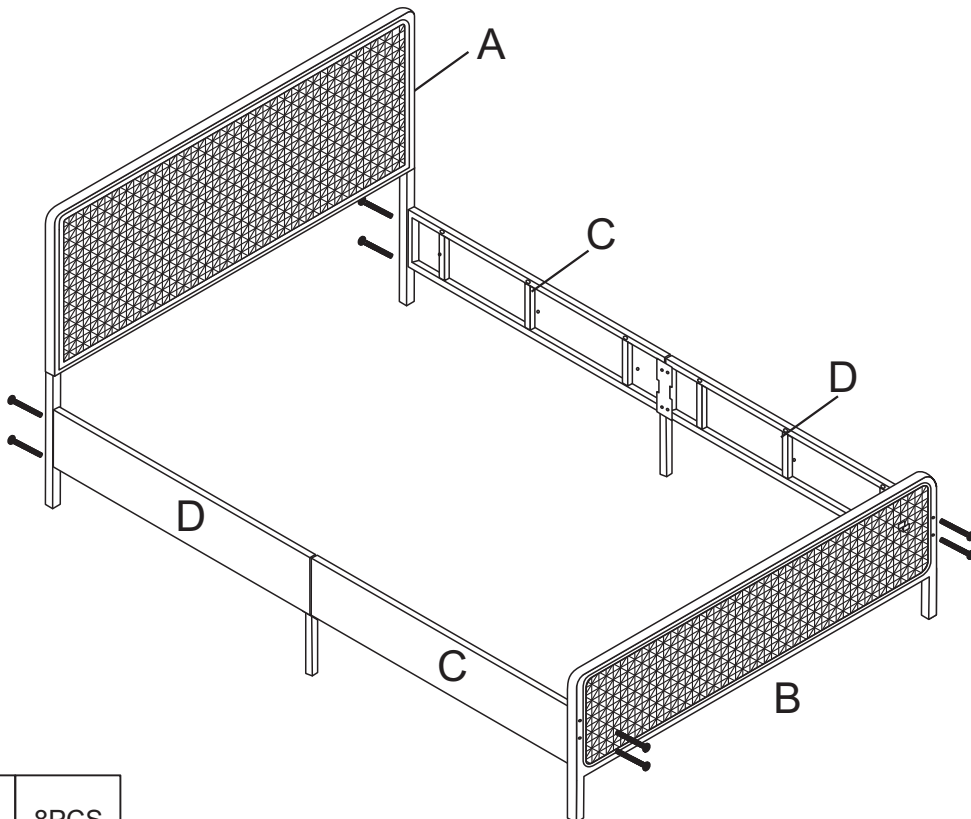

1

 M8 x 55mm

8PCS

ASSEMBLY INSTRUCTIONS

5

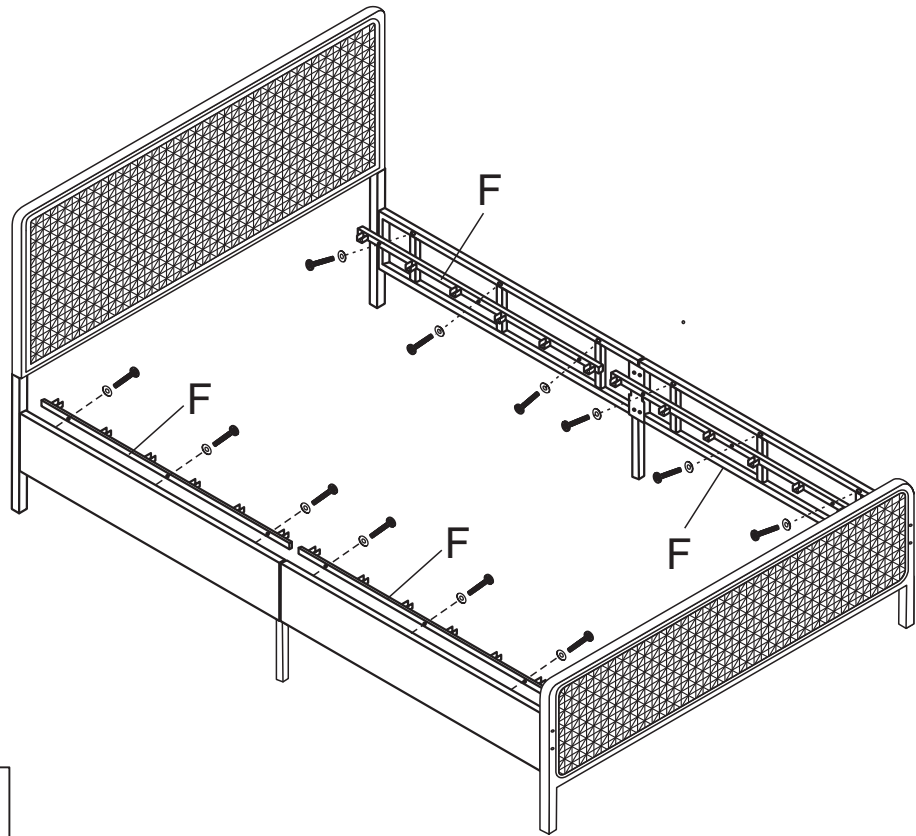

4	 M8 x 25mm	12PCS
---	--	-------

6

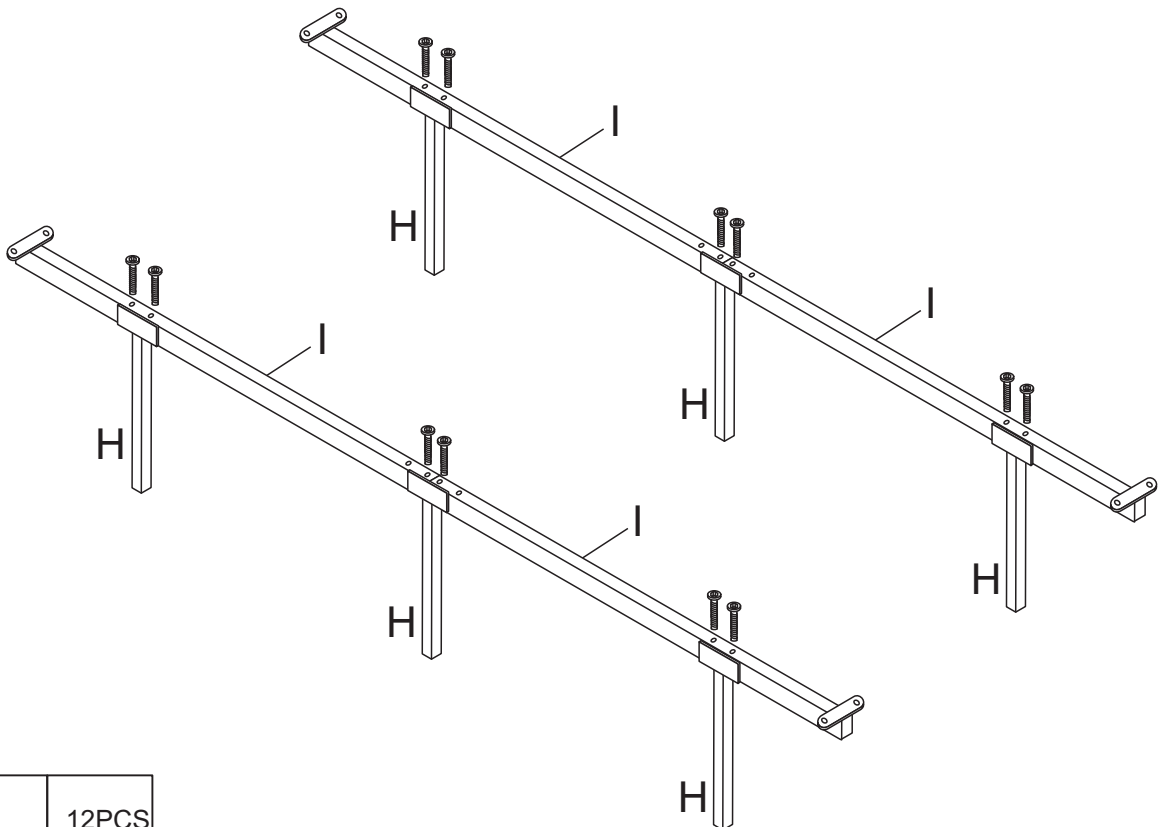



3	 M6x 35mm	12PCS
---	---	-------

ASSEMBLY INSTRUCTIONS

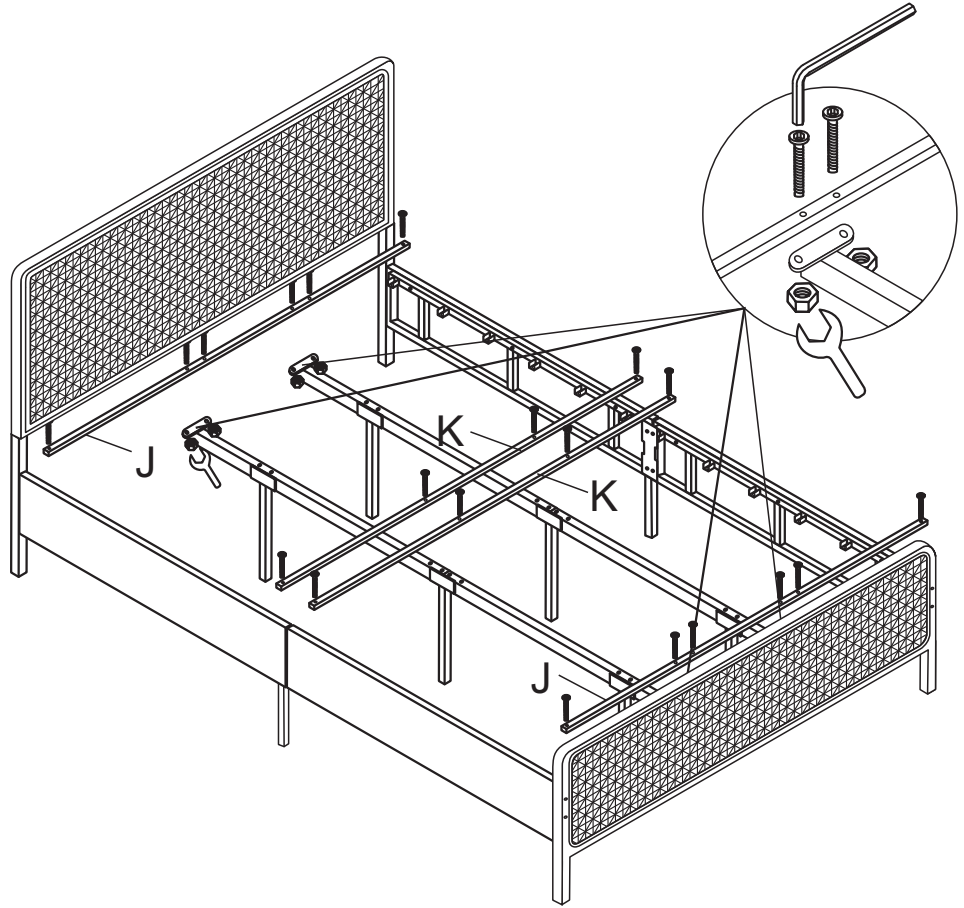
7



2	 M6x 25mm	20PCS
5	 M6	8PCS

8

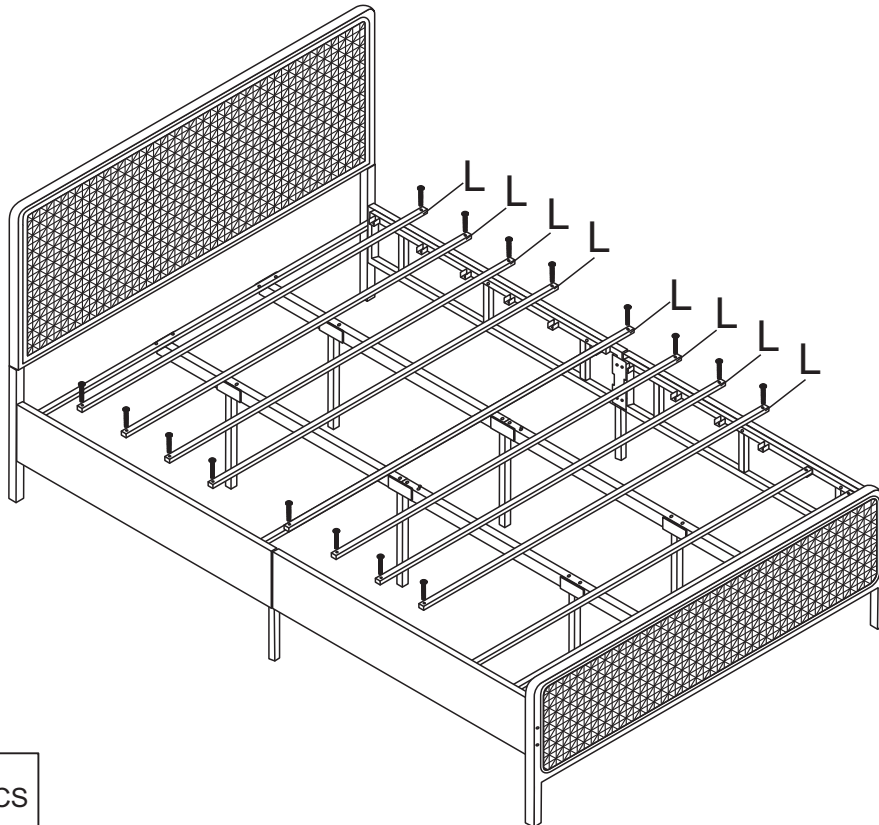

2	 M6 x 25mm	16PCS
---	--	-------

9

