

ASSEMBLY INSTRUCTIONS

Metal Bed Frame Assembly Instructions

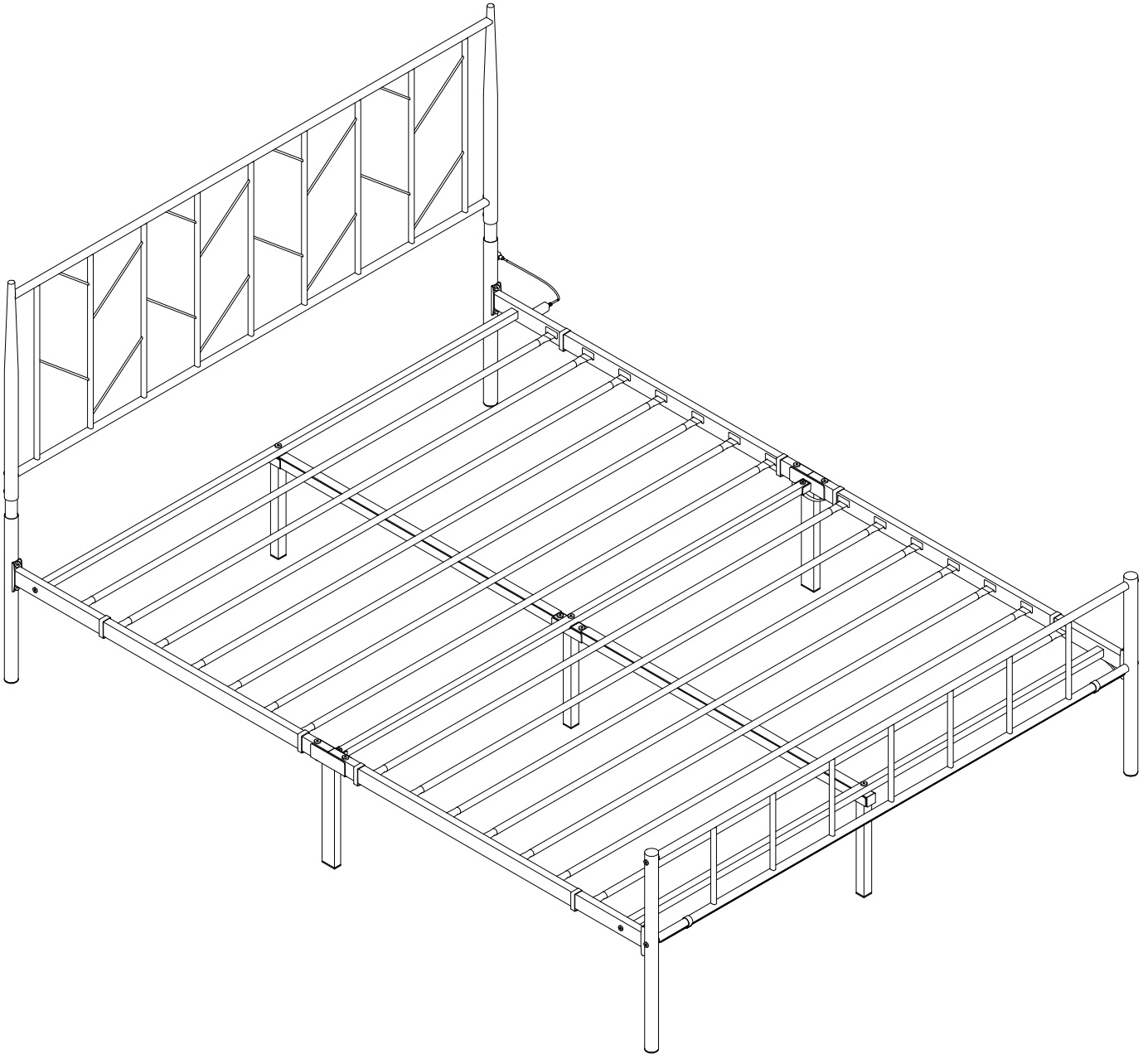

Dear Customers,

Thank you for purchasing our product. Please read this instruction manual carefully after receiving this product. It will help you assemble this product quickly, safely and correctly. You can keep this manual for future reference.

MADE IN CHINA

! IMPORTANT

Please follow the instruction manuals and use a pad to protect the product during your assembly.

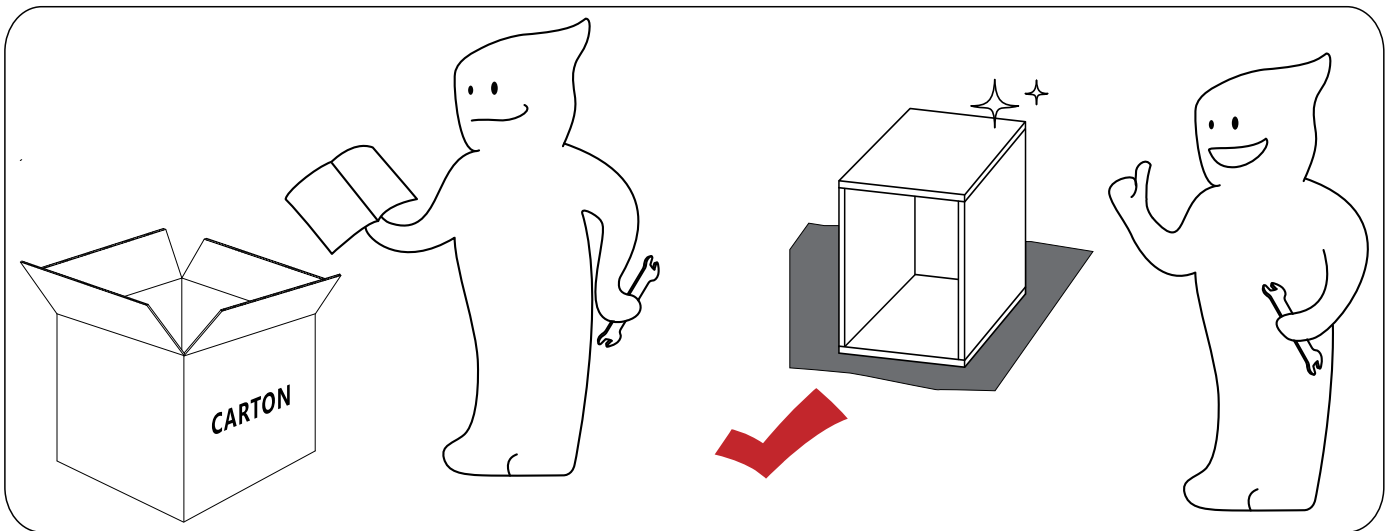
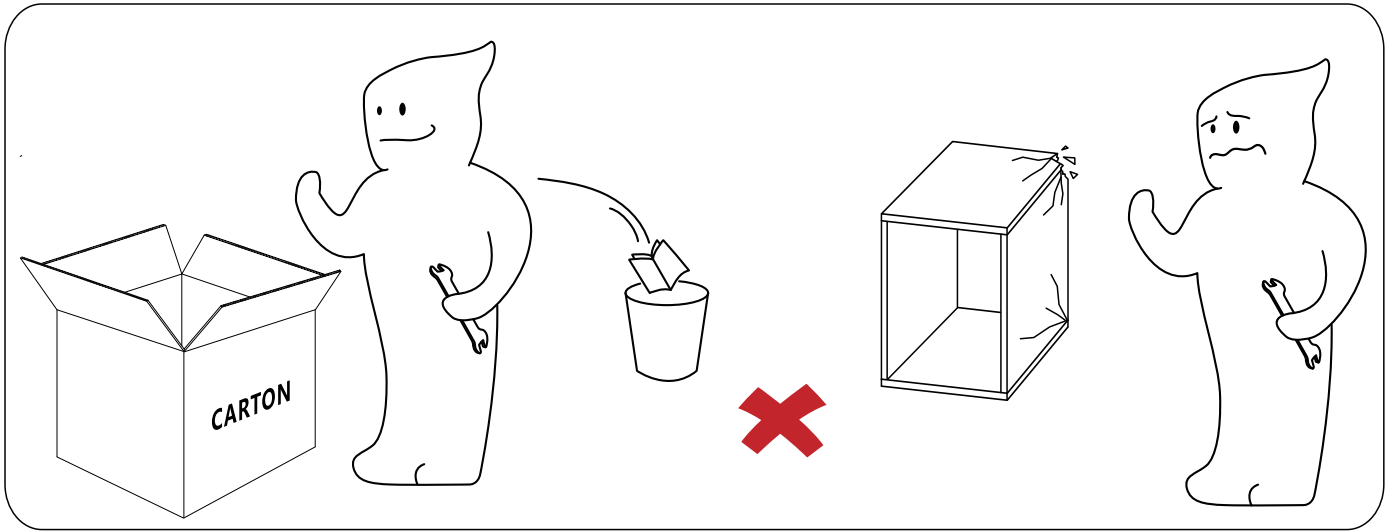

Note:



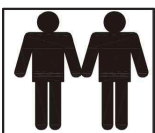

1. Should be assembled on flat ground to keep balance.
2. Before completing the installation, do not tighten the screws.



For easier and better assembly, **2** or more adults are required.

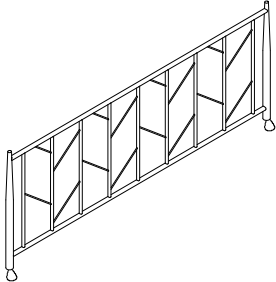
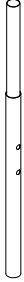
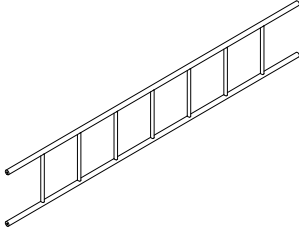

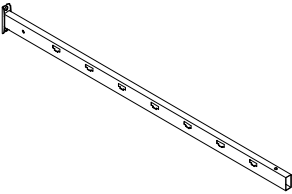
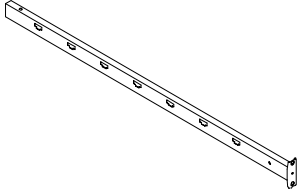
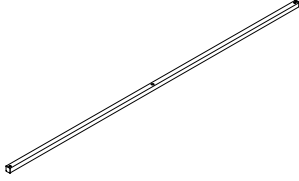
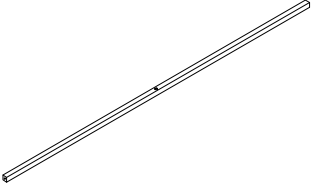
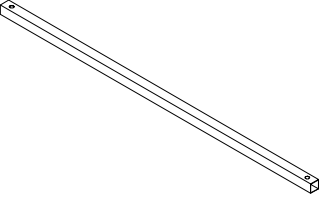
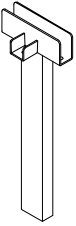
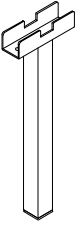

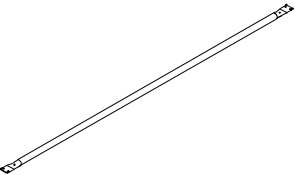
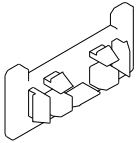
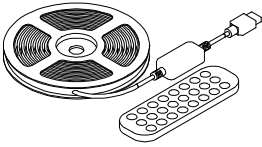
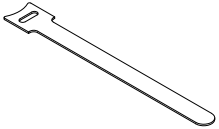
ASSEMBLY INSTRUCTIONS

PARTS LIST

 <p>1</p>	 <p>2</p>	 <p>3</p>	 <p>4</p>
1PC	2PCS	1PC	2PCS
 <p>5</p>	 <p>6</p>	 <p>7</p>	 <p>8</p>
2PCS	2PCS	1PC	2PCS
 <p>9</p>	 <p>10</p>	 <p>11</p>	 <p>12</p>
2PCS	2PCS	1PC	2PCS
 <p>13</p>	 <p>14</p>	 <p>15</p>	 <p>16</p>
14PCS	28PCS	1PC	10PCS

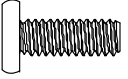
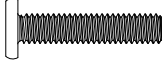
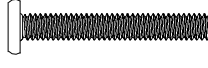
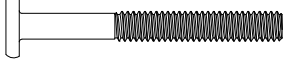
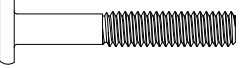
ASSEMBLY INSTRUCTIONS

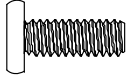
HARDWARE LIST

<p>A</p>  <p>5/16 X 19mm</p> <p>8PCS</p>	<p>B</p>  <p>1/4 X 30mm</p> <p>6PCS</p>	<p>C</p>  <p>1/4 X 45mm</p> <p>4PCS</p>	<p>D</p>  <p>5/16 X 55mm</p> <p>3PCS</p>
<p>E</p>  <p>5/16 X 48mm</p> <p>4PCS</p>	<p>F</p>  <p>5/16 X 34mm</p> <p>2PCS</p>	<p>G</p>  <p>1/4 X 19mm</p> <p>4PCS</p>	<p>H</p>  <p>M4</p> <p>1PC</p>

ASSEMBLY INSTRUCTIONS

Remove the plug from the headboard tube.

1

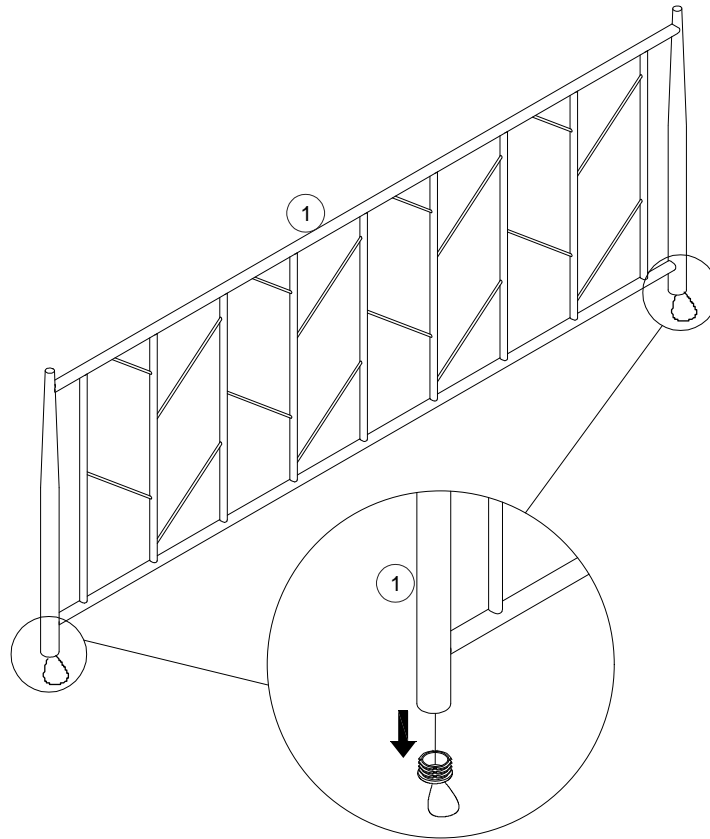

2

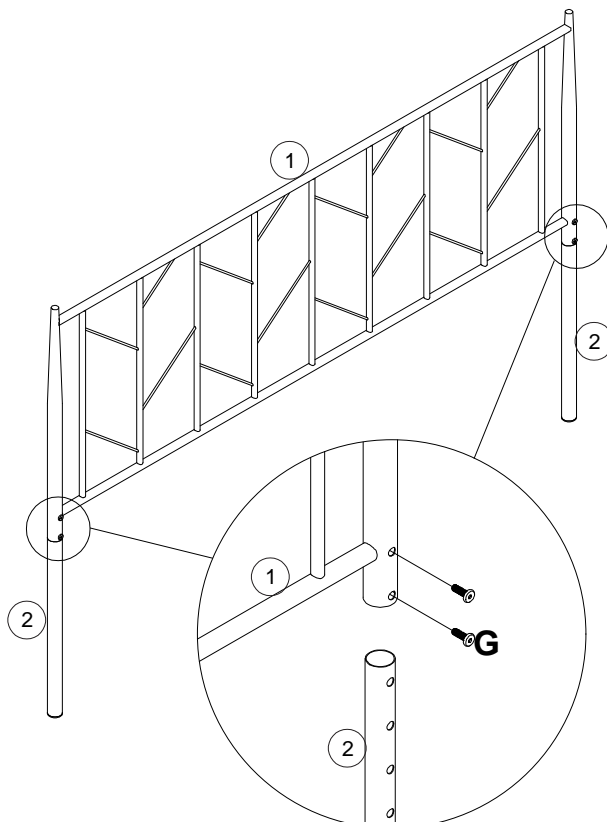

First gear

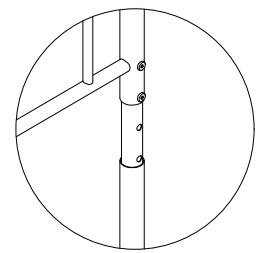
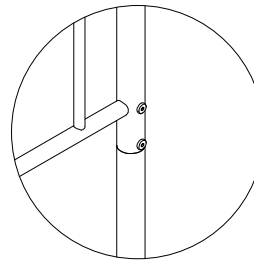

Third gear

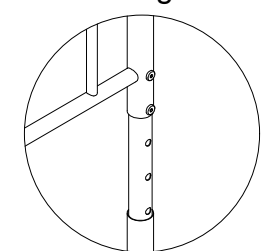
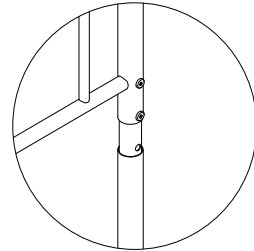

Second gear

Fourth gear





G		1/4x19	4PCS
H		M4	1PC

ASSEMBLY INSTRUCTIONS

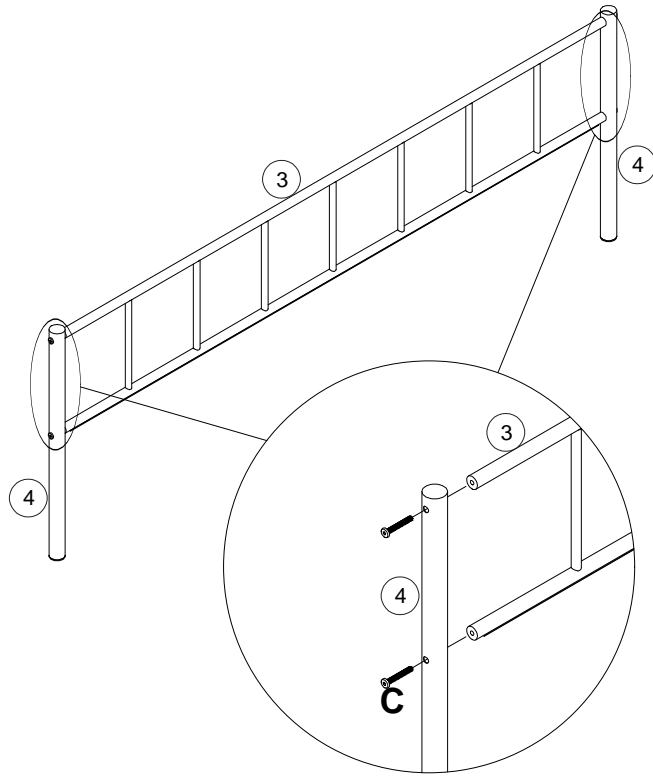

3

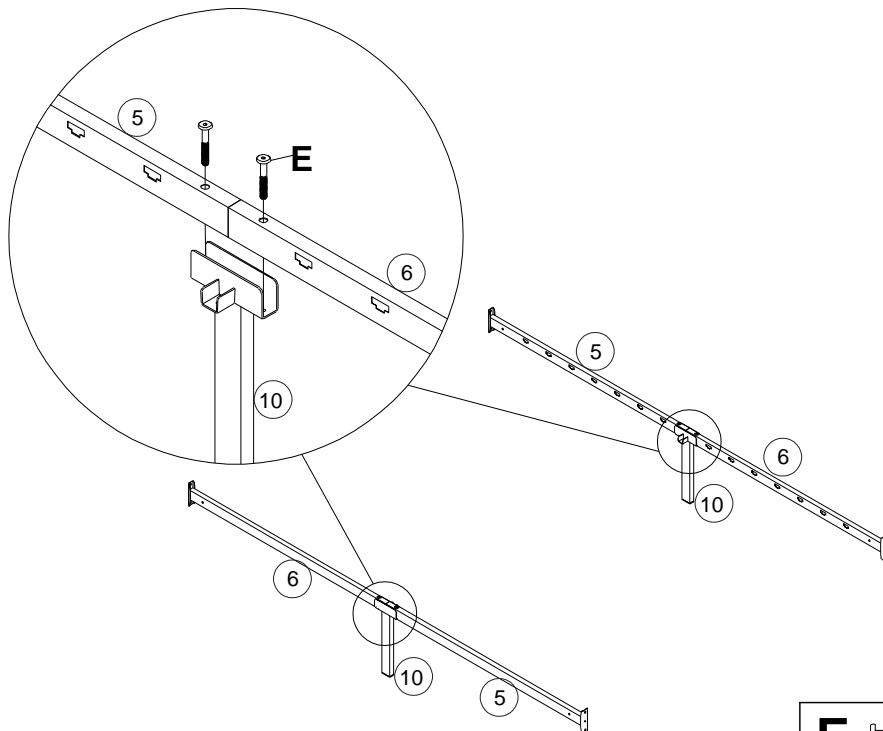

C		1/4x45	4PCS
H		M4	1PC

4





E		5/16x48	4PCS
H		M4	1PC

ASSEMBLY INSTRUCTIONS

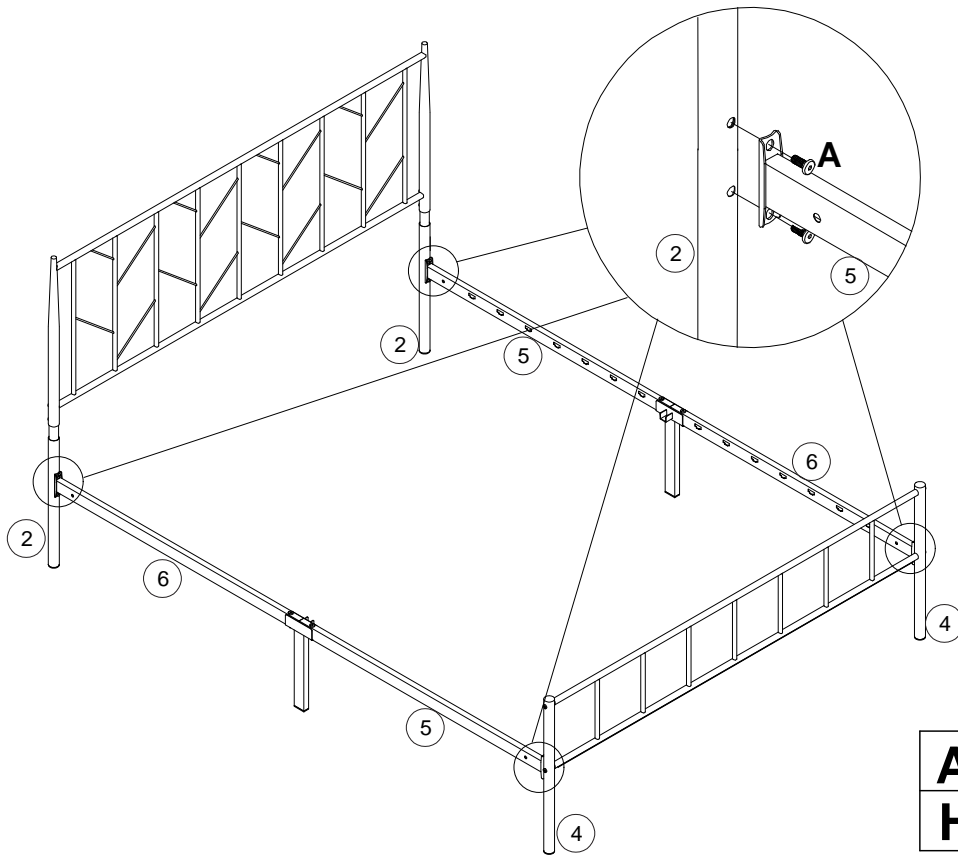

5

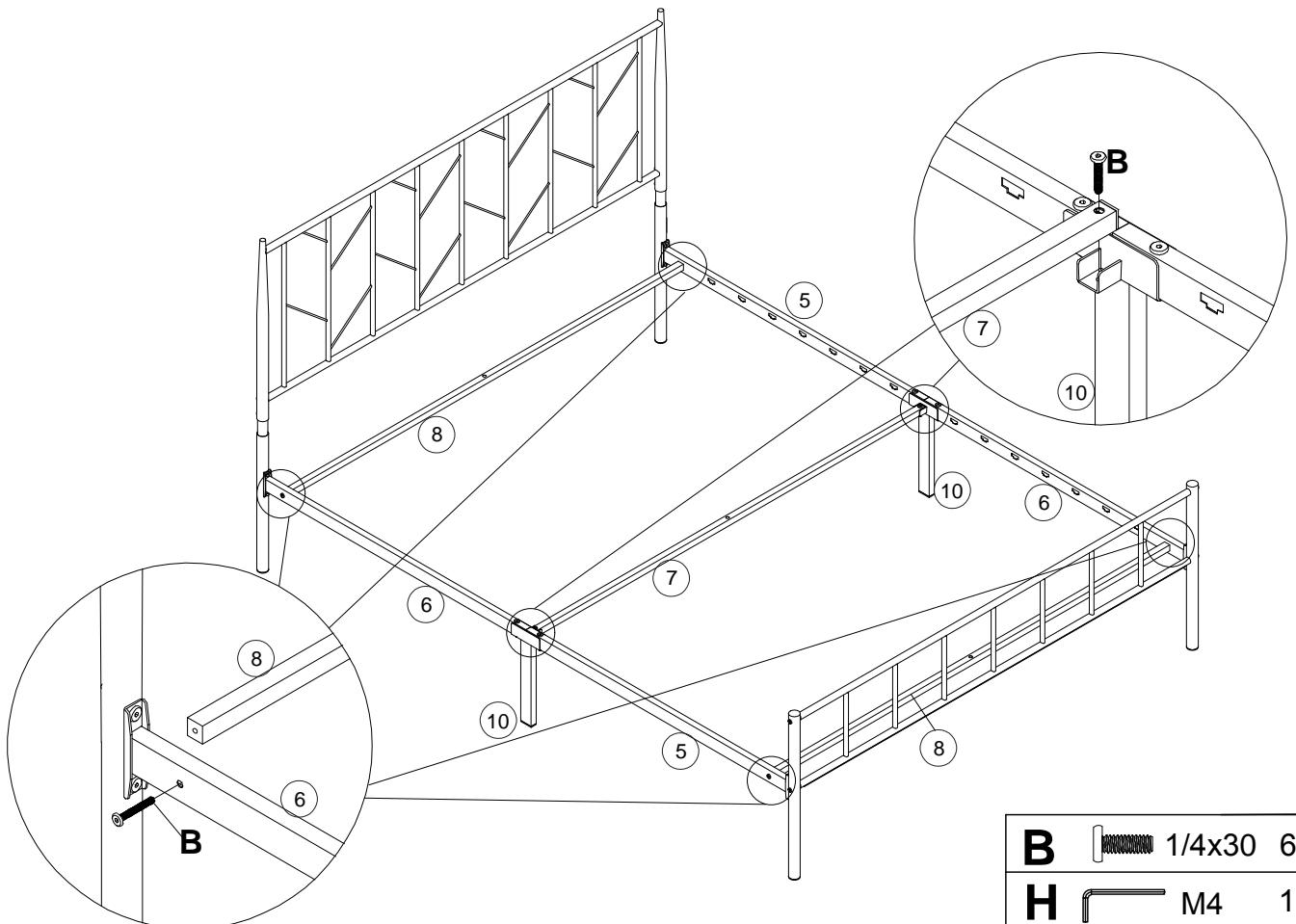

A		5/16x19	8PCS
H		M4	1PC

6



B		1/4x30	6PCS
H		M4	1PC

ASSEMBLY INSTRUCTIONS

7

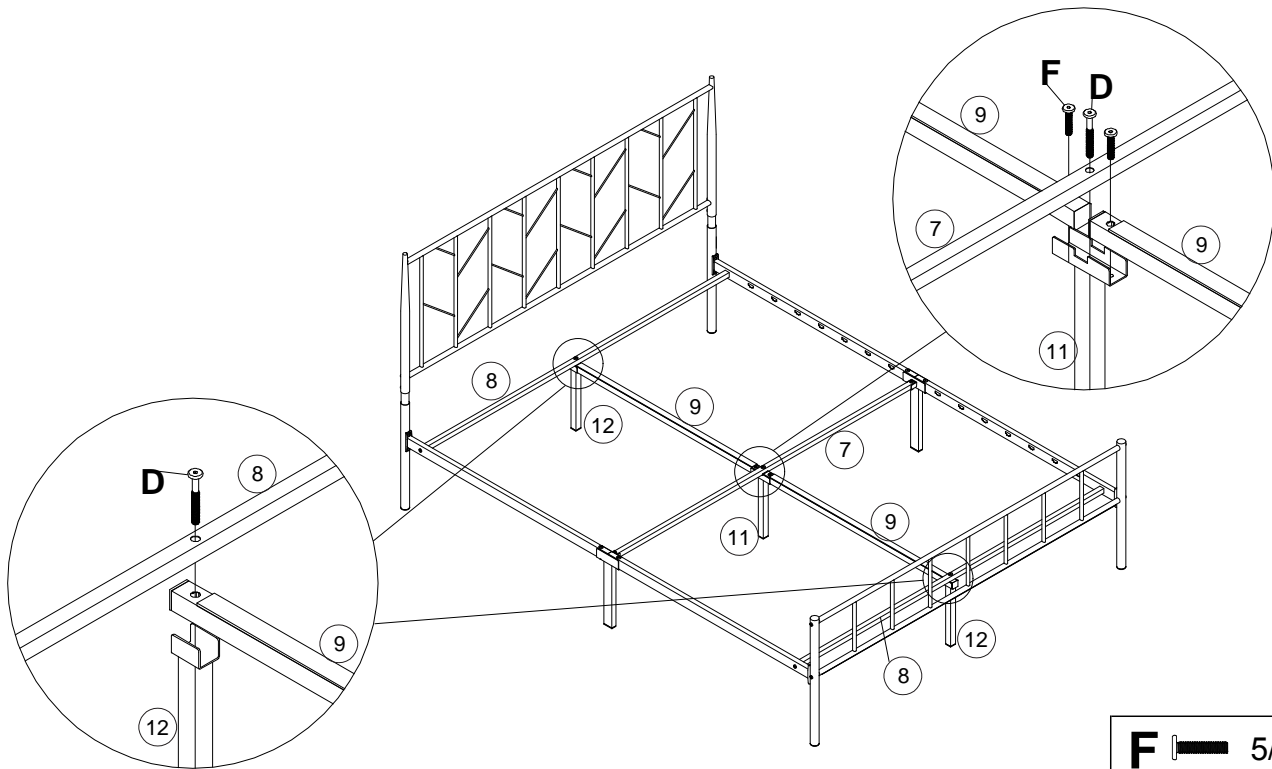

F		5/16x34	2PCS
D		5/16x55	3PCS
H		M4	1PC

Insert 13 into Rail Section as shown. Then lock 14 to fix 13.

8

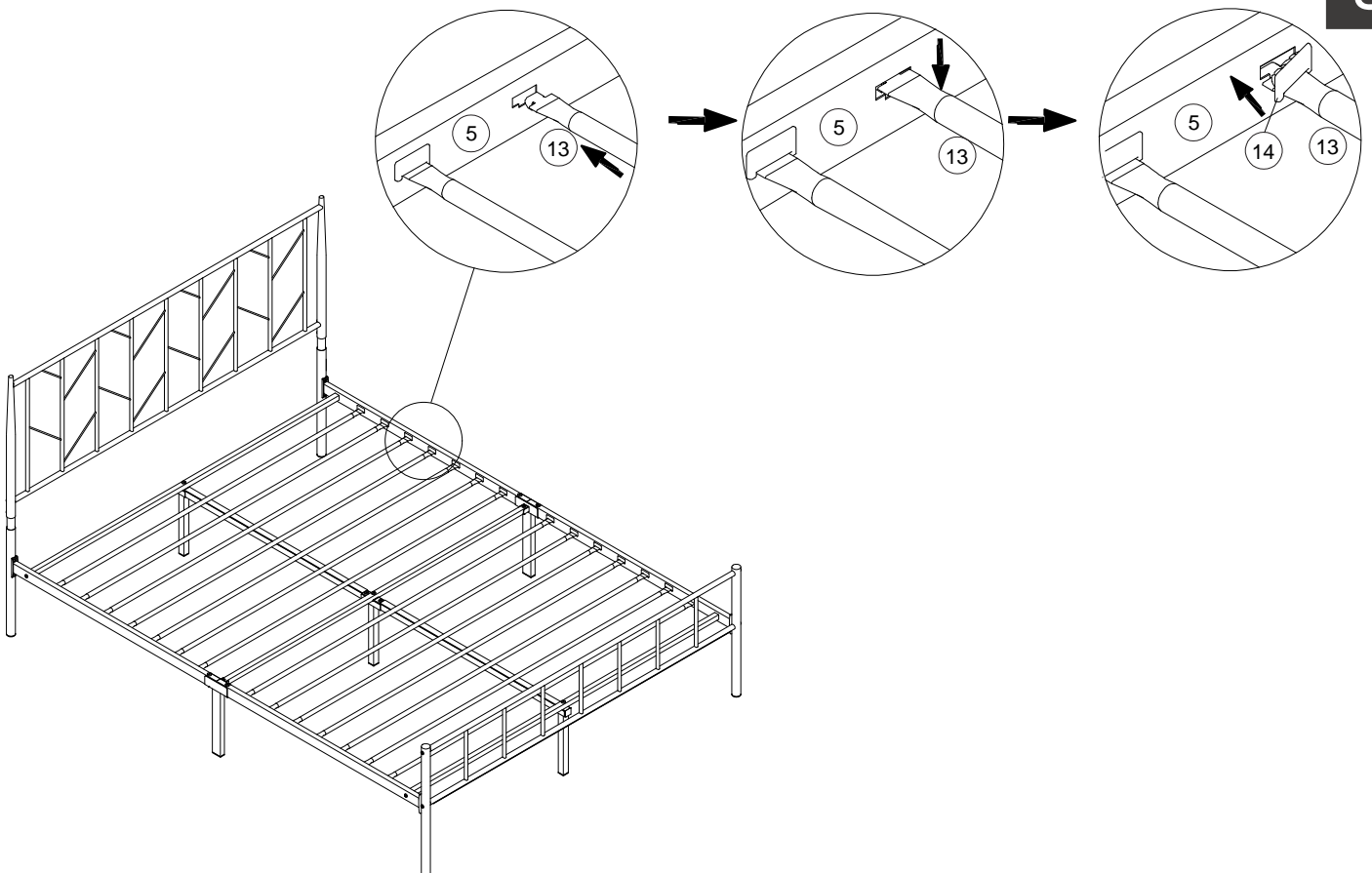

ASSEMBLY INSTRUCTIONS

9

Attach the LED strip to the back of the bed frame as per diagram.

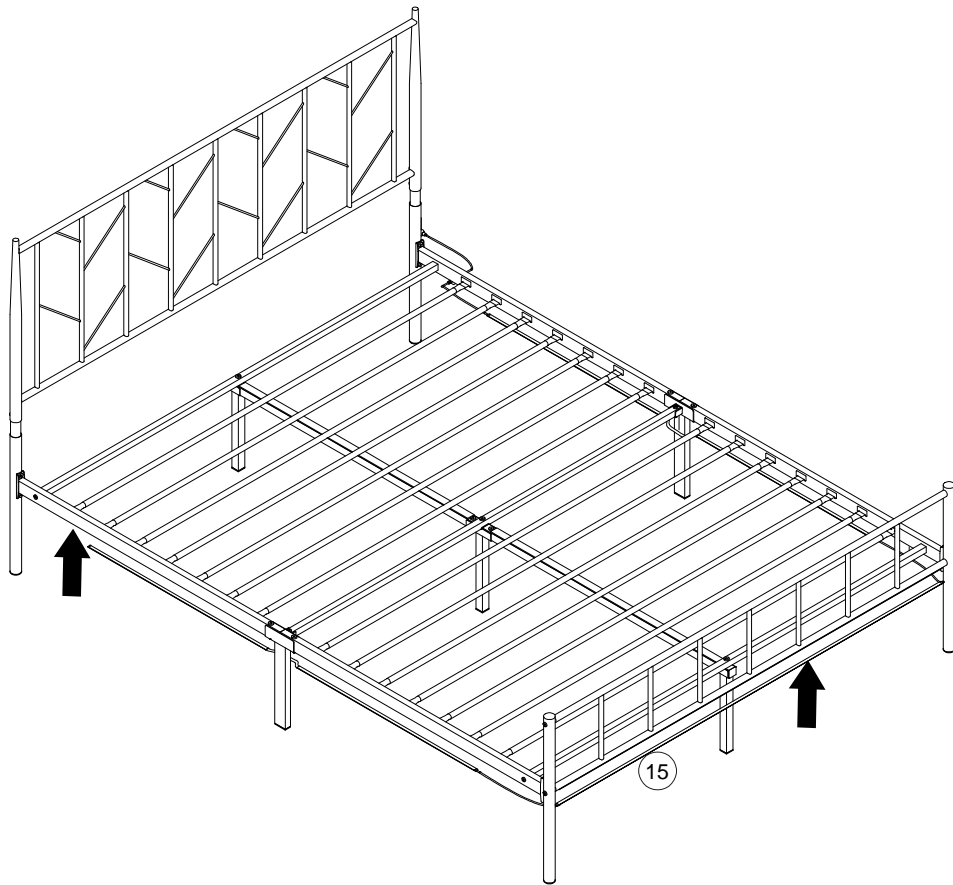
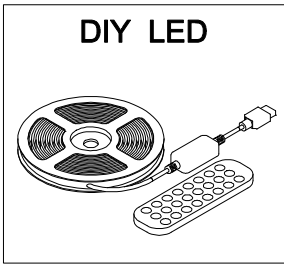

10

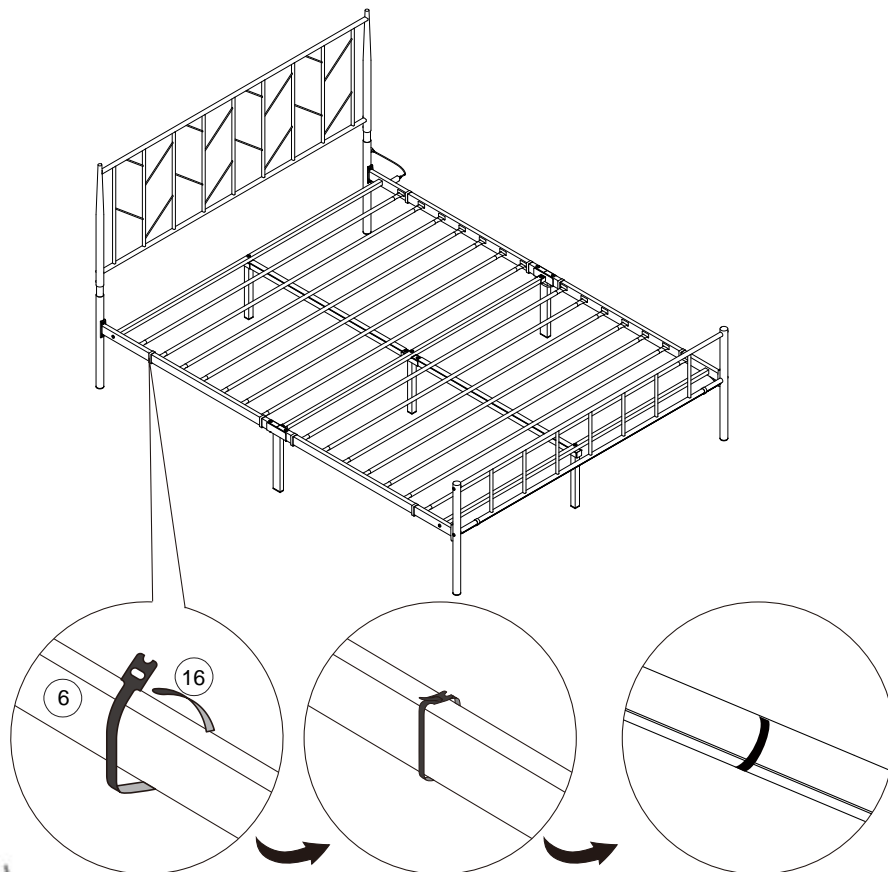

Installation Complete